



Model: **PR36**

Product Type:

**AIR RIVETER - 3/32", 1/8",
5/32", AND 3/16" CAPACITY**

Foreseen Use of the Tool

Do not use the tool outside of the design intent.
Never modify the tool for any other purpose, or for its use.



Safety Precaution

Caution: To help prevent personal injury

- Normal use of this product is likely to expose the user to dust and/or microscopic particles containing chemicals known to the State of California to cause cancer, birth defects or other reproductive harm. Always wear appropriate safety equipment and clothing when using this product. Study, understand and follow all instructions provided with this product.
- Always wear ANSI approved goggles when using this product.
- Always select the correct accessories of the correct size and design for the job that you are attempting to perform.
- Always work in a clean, safe, well-lit, organized and adequately equipped area.
- Do not begin repairs without assurance that vehicle is in secure position, and will not move during repair.



**Astro Pneumatic
Tool Company**
www.astrotools.com

1 YEAR LIMITED WARRANTY

•Astro Pneumatic Tool Co. warrants our products to the original user against defective material or workmanship for a period of 1 year (except where noted on our price schedule) from the date of 1st use. Astro reserves the right to determine whether the product failed because of defective material, workmanship or other causes and to charge back for missing parts. Astro Pneumatic Tool Co., at its discretion, will repair products covered under this warranty free of charge. The distributor should direct the original user to return the product (with the exceptions listed below) with the distributor's name, address, adequate proof of date of purchase or a copy of warranty card, and a short note explaining the problem. **Failures caused by accident, alteration, or misuse are not covered by this warranty.**

•Astro Pneumatic Tool Co. or its authorized service representatives must perform all warranty repairs. Any repair to the product by unauthorized service representatives voids this warranty. The rights under this warranty are limited to the original user and may not be transferred to subsequent owners.

•This warranty is in lieu of all other warranties, expressed or implied, including warranties of merchantability and fitness for a particular purpose. Some states do not allow the exclusion of limitations of incidental or consequential damages so the above limitations may not apply to you. All claims must be sent to:

Astro Pneumatic Tool Company
372 Old US Highway 52 South
Mt. Airy, NC 27030

Product Information:

Includes the following nosepieces: 3/16"(4.8mm), 5/32"(4mm), 1/8"(3.2mm), 3/32"(2.4mm)

- Powerful, durable, high speed production tool
- Air release valve quickly returns for high speed assembly operations
- Performs well at any angle
- Gets into hard-to-reach areas
- Provides quick, quiet and comfortable operation preventing user fatigue

SPECIFICATIONS:

Rivet Capacity: 3/16"
Overall Length: 10-7/8" (280mm)
Net Weight: 3-1/8 lbs. (1.43kg)
Stroke: 16mm
Pulling Pressure: 1938 lbs.
Air Inlet Thread NPT: 1/4"
Air Hose I.D. Size: 3/8" (10mm)
Avg. Air Consumption: 2.320 Liter/Stroke
Air Pressure: 90-120psi

Important

Read these instructions carefully before installing, operating, servicing or repairing this tool. Keep these instructions in a safe accessible place.



**PLEASE DO NOT RETURN ANY PRODUCT WITHOUT CALLING
1-800-221-9705 FOR INSTRUCTIONS**



Unpacking

When unpacking, check the parts diagram and part number listing on page 5 to make sure all parts are included. If any parts are missing or damage, please call your distributor.

AIR RIVETER - 3/32", 1/8", 5/32", AND 3/16" CAPACITY





Model: **PR36**

Product Type:
**AIR RIVETER - 3/32", 1/8",
5/32", AND 3/16" CAPACITY**



WARNING



- Air tools should not be used in potentially explosive atmospheres unless especially designed for that purpose.
- Unexpected tool movement or breakage of inserted tool may cause bodily injury.
- Air tools should be disconnected before changing or servicing any parts.
- Never put any body part, clothing hair etc. between the tool and the work area as serious bodily injury can result.
- Guard against the risk of being injured by whipping air hoses.
- Guard against unexpected tool movement or breakage of the rivet which may cause injury.
- Unstable postures may not allow counteracting of normal or unexpected movement of the air tool.

GENERAL OPERATION

After unpacking the air powered rivet gun, make sure all of the parts listed are supplied. In addition to parts supplied are two wrenches you will need for replacement of various parts on the PR36. Keep the packages containing wrenches, one 3/32 rivet nosepiece, one set of jaws and the bottle in a safe place. Install the plastic rivet catcher (bottle) (#PR36-15) and add the 1/4 NPT air nipple to the air inlet side located near the base. Add a few drops of air tool oil or #10 Spindle oil to the air inlet near the base of the air riveter also add a drop or two of oil to the Nose Piece Jaws (#PR36-4) through the end of the Nose Piece (#PR36-1). Next squeeze the operating handle Trigger (#PR36-25) several times before inserting a rivet.

AIR SUPPLY

The oil and water extractor should not be mounted on or near the air compressor. The temperature of air is greatly increased during compression. As the air cools down to room temperature, in the air line, on its way to the Air Power Tool, the moisture contained in it condenses. Thus, for maximum effectiveness, the oil and water extractor should be mounted at some point

in the air supply system where the temperature of the compressed air in the line is likely to be lowest. Air lines must be properly drained daily. Each low point in an air line acts as a water trap. Such points should be fitted with an easily accessible drain. See diagram below. Pitch all air lines back towards the compressor so that condensed moisture will flow back into the air receiver where it can be drained off. Drain daily.

SUGGESTED AIR LINE CONNECTION

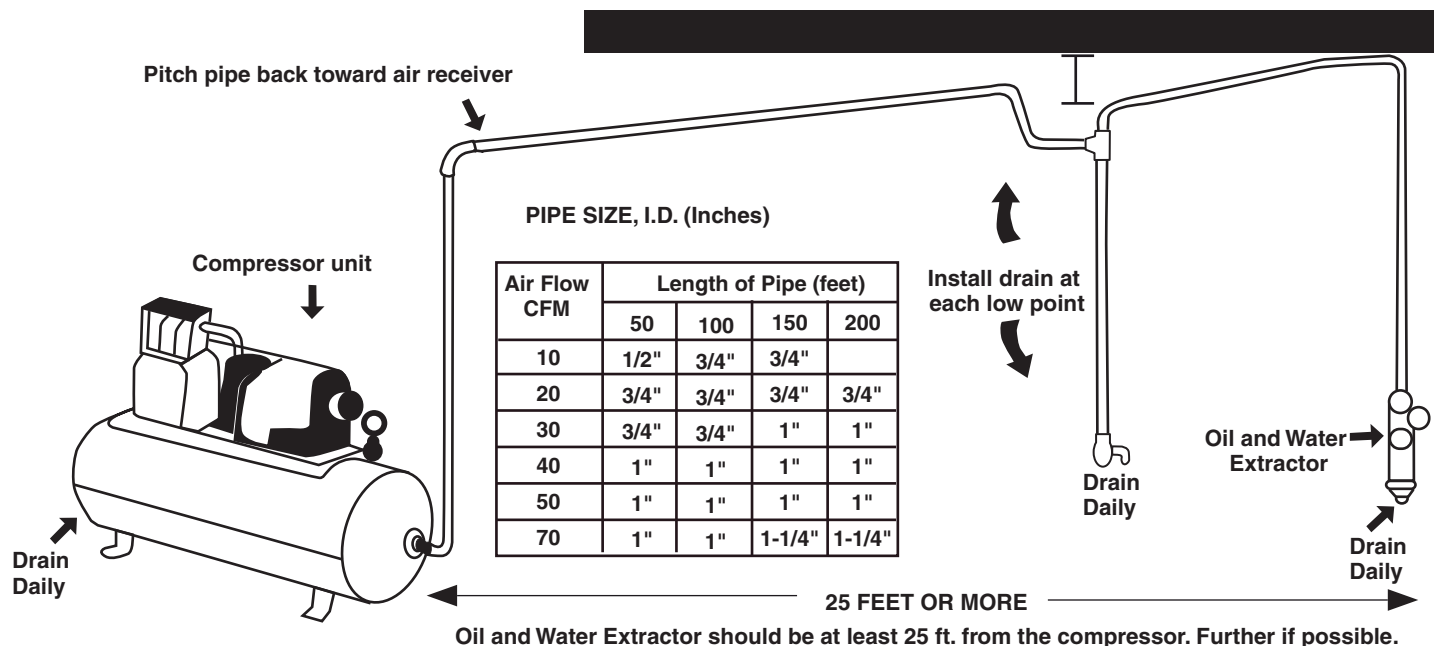

Adjust your air compressor air pressure to 90-120psi, (6.21-8.28 Bars).

NOTE:

If you use extra long air hoses more than 50 feet long you may have to increase the air pressure to compensate for reduced air operating pressure.

Always use clean, dry air that has been filtered and is free of dust, corrosives fumes or moisture. You should drain the air tank daily and clean the filtering system as needed. To use more air pressure will shorten that air tools life and may lead to premature failure of this Air Riveter Gun and could cause injury. Use the standard air supply information located in the above diagram.



Model: **PR36**

Product Type:

**AIR RIVETER - 3/32", 1/8",
5/32", AND 3/16" CAPACITY**

OPERATION

When you insert a rivet keep your hands clear of Trigger(#PR36-25). Insert rivet shank till the button is seated against the Nose Piece (#PR36-1), just prior to squeezing the trigger put a slight amount of push pressure against the rivet and work piece. Most of the time when using aluminum rivets one squeeze of the trigger will be sufficient to set the rivet, however it may take more than one squeeze depending on the length of the rivet and the type of rivet material (aluminum or steel). Make sure that if the rivet has not set that you release the trigger and push the nose piece against the rivet button again till the shank separates from the rivet.

It is easier to replace the nose pieces if you remove the Outer Cylinder (#PR36-02) there by relieving spring pressure on the nose piece. Please refer to FIG. 1. You must also remove the outer cylinder if you are going to replace the set of jaws (3 required) (#PR36-04). Please refer to FIG. 4. Unlike the older models, the PR36 uses one set of jaws for all rivet sizes. Any time you remove the Outer Cylinder always add a little light grease to the Principal Axis (#PR36-09) that the Jaw Cylinder (#PR36-07) screws onto. Please refer to FIG. 2. You will find that one set of jaws will probable last a very long time.

Daily: Add a few drops of good quality air tool oil to the air inlet
When necessary add a drop or two of good quality air tool oil thru the Nose Piece (#PR36-01)) to lubricate the rivet shank jaws.
Always empty the plastic rivet catcher (bottle) (#PR36-15) after it fills to no more than 25% of its capacity or the rivets might start stacking upon one another.
Always keep your air riveter clean and oiled, use only filtered air from your air compressor that does not contain debris and water as unfiltered air can cause premature failure of your air tools.

SERVICING COMPONETS

Before performing any service or maintenance to the air powered rivet gun and/or its componets, always disconnect the air supply and bleed off any air from the rivet gun by squeezing the handle several times.

How to change nose pieces?

1. Remove outer cylinder (#PR36-02) as in FIG. 1 with the wrenches supplied.
2. Unscrew nose piece (#PR36-01) from outer cylinder, thread the desired nose piece onto the outer cylinder just 2 or 3 threads. Please refer to FIG. 3.
3. Next, add a few drops of a good quality air tool oil to the jaws and also add a little light grease to the smooth principal axis (#PR36-09) of the jaw cylinder threaded shaft.
4. Finally, screw the outer cylinder back onto the rivet gun by hand and tighten both the nose piece and the outer cylinder with the wrenches supplied.

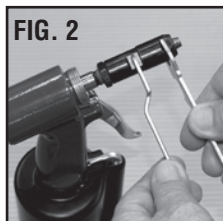

How to change jaw assembly if ever necessary?

1. Remove outer cylinder (#PR36-02) as in FIG. 1.
2. Next, using the two wrenches supplied to unscrew jaw carrier (#PR36-03) from jaw cylinder (#PR36-07) as in Fig. 2. Unscrew by hand the jaw cylinder holding the rivet gun on a flat surface this will allow the jaw pusher (#PR36-05) and the jaw pusher spring (#PR36-06) to remain together as an assembly. Please refer to FIG. 3. Be careful when unscrewing the jaw carrier as there is a slight spring pressure forcing the jaw carrier away from the handle.

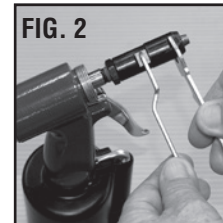
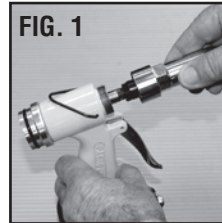

3. When the jaw carrier is unscrewed, tilt the nose part of the jaw carrier at a slight downward angle to help prevent the jaws from falling out see FIG. 3.
4. Before reassembly thoroughly clean with a brush and lubricate all inner assembly parts with good quality air tool oil.

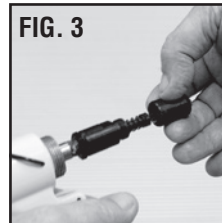

5. Assembly of jaws set PR36-04. Hold the jaw carrier in the palm of your hand as in FIG. 4 leaving about 1/4" (6MM) space between the palm and the jaw carrier.
6. Next, drop each jaw into the jaw carrier at 120 degrees angle till all three jaws are evenly protruding through the jaw carrier. You may find a small amount of light white grease will hold each jaw to one another as well as holding the individual jaws in the jaw carrier.
7. While holding the rivet gun bottom down on a flat surface, reassemble the jaw carrier to the jaw cylinder, and reverse the removal procedure for reassembly.

NOTE: Be careful that all of the jaws are aligned properly and protruding evenly through the jaw carrier before reassembling.

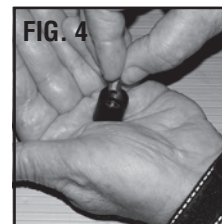

8. After assembling and tightening the jaws in the jaw carrier check the head length of the rivet gun head using the wrench provided as in FIG.5.

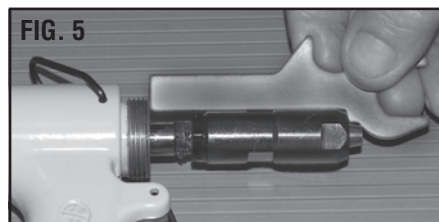



Model: **PR36**

Product Type:

**AIR RIVETER - 3/32", 1/8",
5/32", AND 3/16" CAPACITY**

MAINTENANCE

Adding oil for hydraulic riveter

1. Turn off air supply by disconnecting air hose from rivet gun. Bleed any air remaining by squeezing the handle several times.
2. Use the supplied wrench to dismantle the riveter head as in FIG. 1.
3. Use wrench supplied to open the cover located on the bottom of the rivet gun as in FIG. 2.
4. Remove piston from cylinder as FIG. 3 illustrates.
5. Clean the inside of the cylinder, clean the piston stem and lubricate the o ring cover seal as in FIG. 4
6. Lubricate the intake with a good quality hydraulic oil, (fill only to the top of the center intake tube) as shown in FIG. 5 add a light coat of grease to the inner cylinder wall.
7. Reassemble as in FIG. 6.

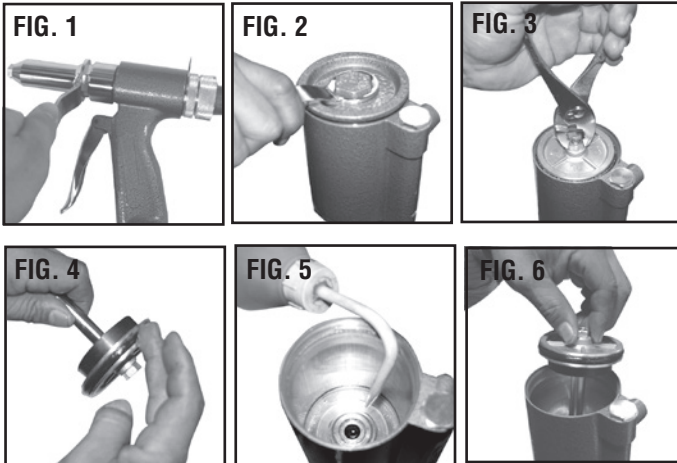

Lubrication

Every three to four hours of operation, lubricate the jaws (#PR36-04) and the principal axis (#PR36-09) is necessary.

Use of a thicker oil can lead to adverse performance or malfunction if a thicker oil is used by accident, wash it away immediately.

Storage

Avoid storing air tools in a locations subject to high humidity. If the tool is left after being used, the residual moisture inside the tool can cause rust. Before storing and after operation, oil the tool at the air inlet with a good quality air tool oil and run the tool for several cycles.

Disposal

Dispose the worn out tool according to national regulations.

Ordering Service Parts

For further operational and handling information or for replacement parts and components, contact the sales agent from whom you purchased the tool or the service division of our company.

***In ordering parts and components, give each part number, name and quantity.**

Cleaning for the Head of Riveter

1. Turn off air supply. Assure all pressure is released prior to disassembly.
2. Use spanner wrench to dismantle the riveter head as FIG. 1.
3. Use spanner wrench to disassemble as shown in FIG. 2.
4. Clean all inner/assembly parts of the riveter head with a brush.
5. Reassemble the inner/assembly parts.
6. Oil the parts and reassemble riveter head completely.

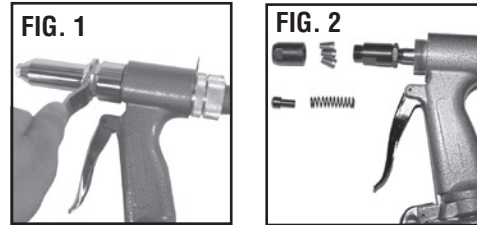

AIR RIVETER - 3/32", 1/8", 5/32", AND 3/16" CAPACITY



Product Information:

- Includes the following nosepieces: 3/16" (4.8mm), 5/32" (4mm), 1/8" (3.2mm), 3/32" (2.4mm)
- Powerful durable, high speed production tool
- Quick release air valve permits cylinder to return quickly for high speed assembly operations: Prevents overloading for long life
- Performs well at any angle
- Gets into hard-to-reach areas
- The 3/16" Nose piece is located on the end of the Outer Cylinder (PR36-02).The 5/32", 1/8" and 3/16" are threaded into the bottom Air Cylinder lid (PR36-24)
- Provides quick, quiet and comfortable operation preventing user fatigue

PARTS BREAKDOWN

Call 1.800.221.9705 for questions concerning performance of the product or other inquiries.

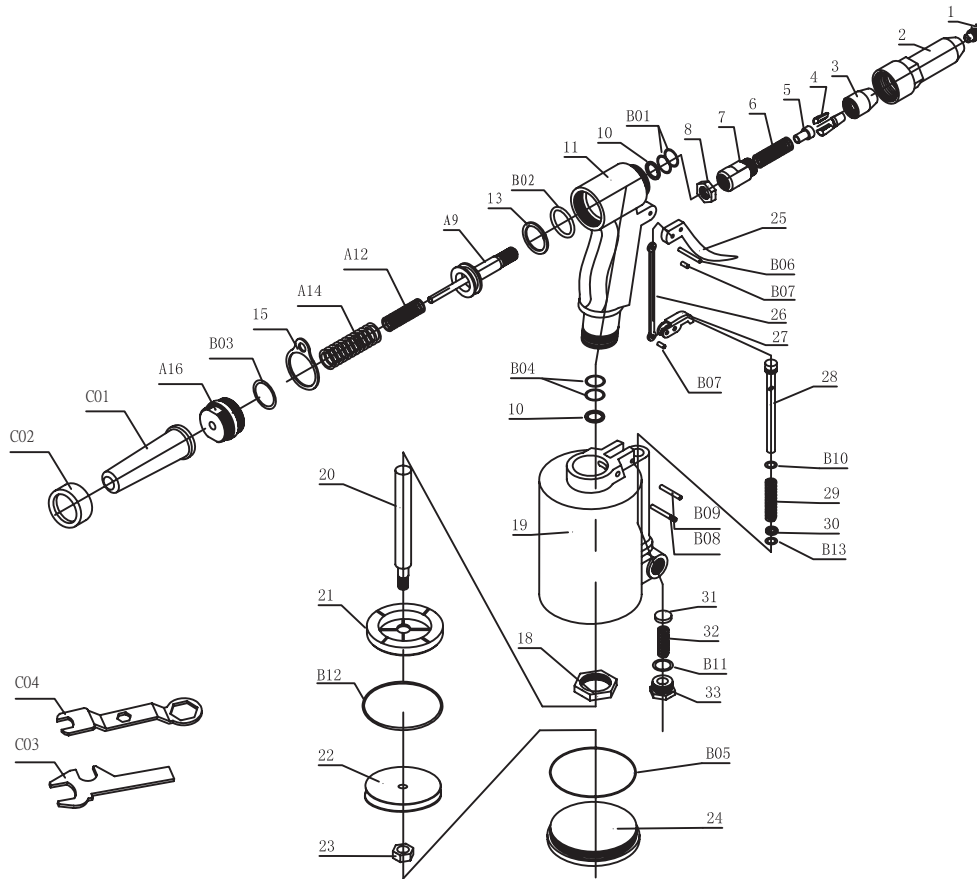

Parts List

Index No.	Part No.	Description	No. Req'd	Index No.	Part No.	Description	No. Req'd
1	PR36-01	Nosepiece	4	27	PR36-27	Press plank	1
2	PR36-02	Outer cylinder	1	28	PR36-28	Air valve	1
3	PR14-03	Jaw carrier	1	29	PR36-29	Valve spring	1
4	PR14-04	Jaws	1	30	PR36-30	Copper wash	1
5	PR14-05	Jaw pusher	1	31	PR36-31	Airproof plastic	1
6	1426-07	Jaw push spring	1	32	PR36-32	Airproof spring	1
7	PR36-07	Jaw cylinder	1	33	PR36-33	Airproof nut	1
8	PR36-08	Case lock nut	1	B01	PR36-B01	O ring	2
A9	PR36-A09	Principal axis	1	B02	PR36-B02	O ring	1
10	PR36-10	Plastic ring	2	B03	PR36-B03	O ring	1
11	PR36-11	Handle	1	B04	PR36-B04	O ring	2
A12	PR36-A12	Restore spring	1	B05	PR36-B05	O ring	1
13	PR14-13	Plastic ring	1	B06	PR36-B06	Spring pin	1
A14	PR36-14	Restore spring	1	B07	PR36-B07	Spring pin	1
15	PR36-15	Pothook	1	B08	PR36-B08	Pin	1
A16	PR36-A16	Airproof lid	1	B09	PR36-B09	Spring pin	1
18	PR36-18	Lock nut	1	B10	PR36-B10	O ring	1
19	PR36-19	Air cylinder	1	B11	PR36-B11	O ring	1
20	PR36-20	Pole piston	1	B12	PR36-B12	O ring	1
21	PR36-21	Cushion	1	B13	PR14-31	O ring	1
22	PR36-22	Piston	1	C01	PR36-C01	Bottle	1
23	PR36-23	Nut	1	C02	PR36-C02	Wrench nut	1
24	PR36-24	Air cylinder lid	1	C03	PR36-C03	Wrench	1
25	PR36-25	Trigger	1	C04	PR36-C04	Wrench	1
26	PR36-26	Linker	1				