



Model:

78197

Product Type:

GOLIATH BALL JOINT SERVICE TOOL AND MASTER ADAPTER SET



WARNING



Study, understand and follow all instructions provided with this product. Read these instructions carefully before installing, operating, servicing or repairing this tool. Keep these instructions in a safe accessible place.

Foreseen Use of the Tool

Do not use the tool outside of the design intent. Never modify the tool for any other purpose, or for its use.



WARNING



Caution: To help prevent personal injury

- Use of this product can expose you to chemicals such as phthalates which are known to the State of California to cause cancer, and birth defects or other reproductive harm. For more information go to www.P65Warnings.ca.gov/product. Always wear ANSI approved safety equipment, safety glasses and clothing when using this product. Study, understand, and follow all instructions provided with this product. Failure to read and follow all warnings and operating instructions may result in damages and serious injury or death.
- Always wear ANSI approved goggles when using this product. (Users and By standers).
- Never use this tool for any application other than for which it was designed.
- Only use accessories designed for this tool.
- Never alter or modify this tool in any way.
- Improper operation and/or maintenance of the tool, modification of the tool, or use of the tool with accessories not designed for it could result in serious injury or death.
- Always select the correct accessories of the correct size and design for the job that you are attempting to perform.
- Always work in a clean, safe, well-lit, organized and adequately equipped area.
- Do not begin repairs without assurance that vehicle is in secure position, and will not move during repair.

BEFORE USE

When unpacking, check the parts diagram and part number listing on page 4 to make sure all parts are included. If any parts are missing or damaged, please call your distributor.

DO NOT DISCARD – GIVE TO USER



Astro Pneumatic Tool Company

www.astrotools.com

1 YEAR LIMITED WARRANTY

- Astro Pneumatic Tool Co. warrants our products to the original user against defective material or workmanship for a period of 1 year (except where noted on our price schedule) from the date of 1st use. Astro reserves the right to determine whether the product failed because of defective material, workmanship or other causes and to charge back for missing parts. Astro Pneumatic Tool Co., at its discretion, will repair products covered under this warranty free of charge. The distributor should direct the original user to return the product (with the exceptions listed below) with the distributor's name, address, adequate proof of date of purchase or a copy of warranty card, and a short note explaining the problem. **Failures caused by accident, alteration, or misuse are not covered by this warranty.**
- If one part of this product fails, please do not return the entire product. Astro will replace free of charge component parts of this product that fail within 1 year of first use by the original user. Items included in this category include but are not limited to kits, hand tool kits and any other product where there are multiple items or components that make up the unit. Please contact the phone number below in order to obtain the replacement components covered under warranty.
- Astro Pneumatic Tool Co. or its authorized service representatives must perform all warranty repairs. Any repair to the product by unauthorized service representatives voids this warranty. The rights under this warranty are limited to the original user and may not be transferred to subsequent owners.
- This warranty is in lieu of all other warranties, expressed or implied, including warranties of merchantability and fitness for a particular purpose. Some states do not allow the exclusion of limitations of incidental or consequential damages so the above limitations may not apply to you.



PLEASE DO NOT RETURN ANY PRODUCT WITHOUT CALLING 1-800-221-9705 FOR INSTRUCTIONS



PRODUCT INFORMATION

- Removes and replaces ball joints
- C frame press alone can be used to remove and replace universal joints
- Set includes all the receiver tubes and removing/installing adapters needed to work on press-fit upper and lower ball joints on most GM, Ford and Dodge 2 and 4 wheel drive pickups, vans and sport utility vehicles through 1997
- Also included is the live center forcing screw plug
- Blow molded case for easy storage and transport



Model:

78197

Product Type:

GOLIATH BALL JOINT SERVICE TOOL AND MASTER ADAPTER SET

OPERATING INSTRUCTIONS

Ball Joint Removal and Installation

This tool set is designed for use on all cars and light trucks that have press-fit type ball joints. It will help the user remove and install ball joints without the need to remove the control arm from the vehicle.

NOTE: Some cars and light trucks may have the upper ball joint spot-welded to the control arm. The weld must be cut before attempting to remove the ball joint.

Removal (Item numbers refer to the parts list on page 3)

1. Assemble the ball joint press over the control arm as shown in Figure 1. Select the correct size receiving tube, and position it under the vehicle ball joint as shown.
2. Tighten the forcing screw until the receiving tube contacts the control arm. Check the alignment of all tooling and components, and continue tightening the forcing screw until the ball joint is removed.

Installation

1. Clean the control arm and coat the I.D. with a suitable lubricant.
2. Insert the replacement ball joint as straight as possible into the vehicle control arm.
3. Assemble the ball joint press components as shown in Figure 2. Position the receiving tube, and tighten the forcing screw. Check the alignment of all tooling and components, and continue tightening the forcing screw until the ball joint is firmly seated.

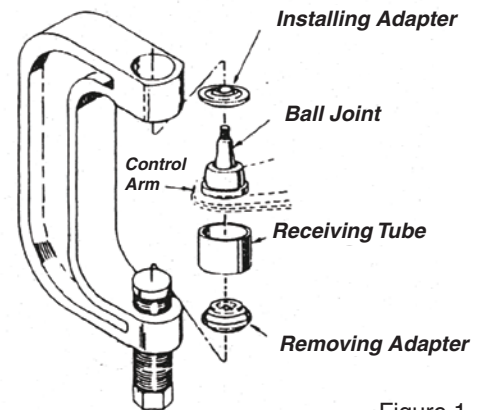

Figure 1

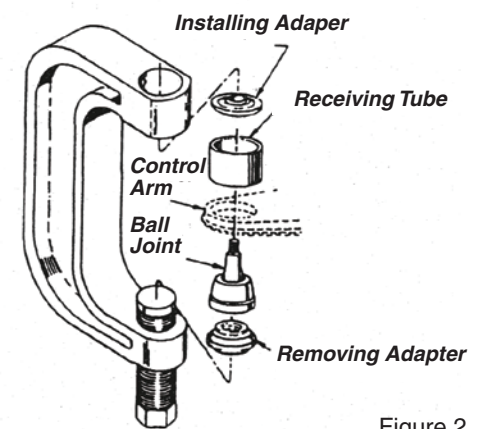

Figure 2



Model:

78197

Product Type:

GOLIATH BALL JOINT SERVICE TOOL AND MASTER ADAPTER SET

DIMENSIONS

7897-21

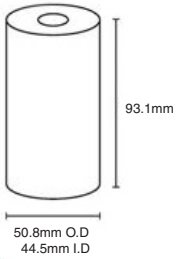

7897-20

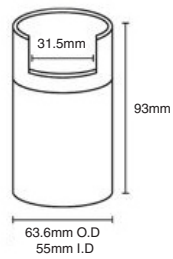

7897-19

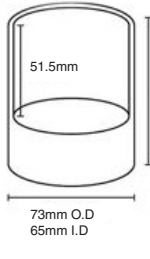

7897-15

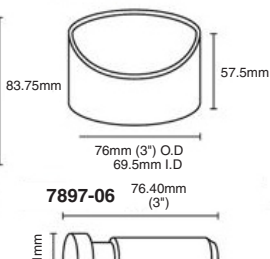

7897-07

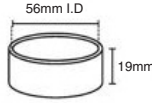

7897-10



7897-11

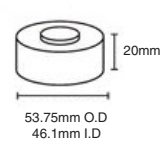

7897-18

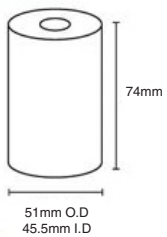

7897-17

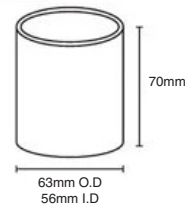

7897-14

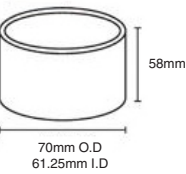

7897-06

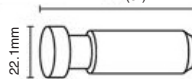

7897-12

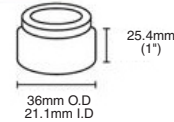

7897-02 2"OD, 1.75" ID, 1.75" L

7897-03 2.48"OD, 2.25" ID, 1.75" L

7897-04 3"OD, 2.75" ID, 2.25" L

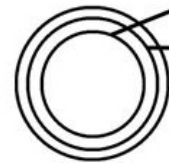

7897-05



78197-01

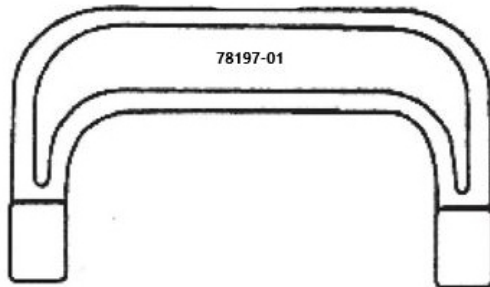

7897-09



7897-08



7897-16

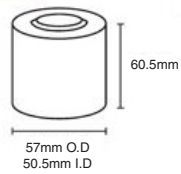

7897-13

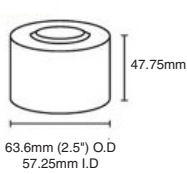



Model:

78197

Product Type:

GOLIATH BALL JOINT SERVICE TOOL AND MASTER ADAPTER SET

PARTS BREAKDOWN

Call 1.800.221.9705 for questions concerning performance of the product or other inquiries.

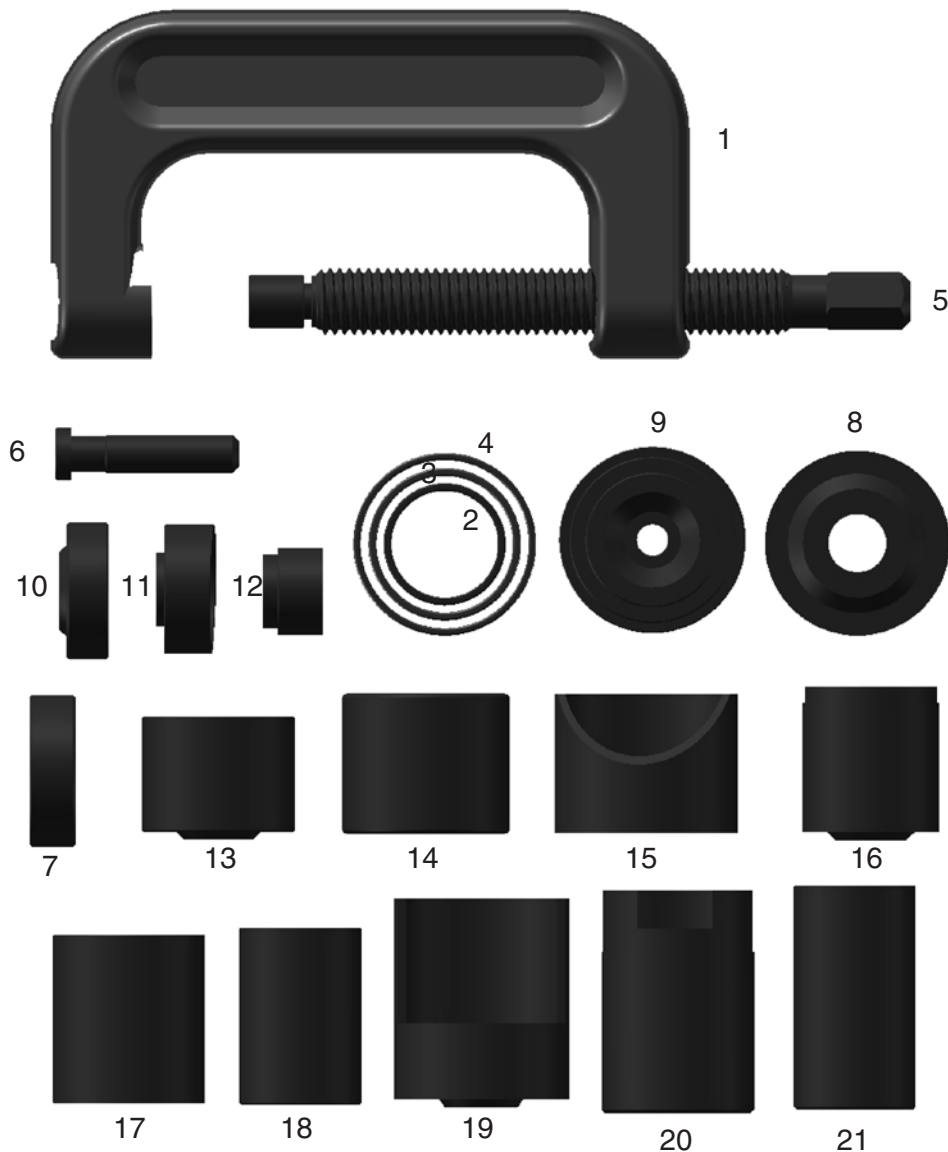

Parts List

Index	Part No.	Description	Qty
1	78197-01	C-Frame	1
2	7897-02	2" OD, 1.75" ID, 1.75" L Receiving Tube	1
3	7897-03	2.5" OD, 2.25" ID, 1.75" L Receiving Tube	1
4	7897-04	3" OD, 2.75" ID, 2.25" L Receiving Tube	1
5	7897-05	Screw	1
6	7897-06	Center Rod	1
7	7897-07	Sleeve	1
8	7897-08	Adapter	1
9	7897-09	Adapter	1
10	7897-10	Adapter	1
11	7897-11	Adapter	1

Index	Part No.	Description	Qty
12	7897-12	Adapter	1
13	7897-13	Adapter	1
14	7897-14	Adapter	1
15	7897-15	Adapter	1
16	7897-16	Adapter	1
17	7897-17	Adapter	1
18	7897-18	Adapter	1
19	7897-19	Adapter	1
20	7897-20	Adapter	1
21	7897-21	Adapter	1



Model:

78197

Product Type:

GOLIATH BALL JOINT SERVICE TOOL AND MASTER ADAPTER SET

BLANK: 78197 does not have all of the recommended adapters, but modification of adapters may or may not work

NA: This tool not needed. Application requires bolt in ball joint, replacing control arm (RCA) or replacing steering knuckle (RSK), see Application description.

Not Listed: 78197 may not work on your application.

GOLIATH BALL JOINT SERVICE TOOL AND MASTER ADAPTER SET

Make	Model	Year	Application	Removal	Installation	
Acura	CL 2.2L	1997	Fr. Upper NA (Bolt in)	NA	NA	
			Fr. Lower applicable in Spindle		21, 06	
	CL 2.3L	(98-99)	Fr. Upper NA (Bolt in)	NA	NA	
			Fr. Lower applicable in Spindle		21, 06	
	CL 3.0L	(97-99)	Fr. Upper NA (Bolt in)	NA	NA	
			Fr. Lower applicable in Spindle		21, 06	
	CL 3.2L	(99-03)	Fr. Lower applicable in Spindle		21, 06	
	ILX	2017	NA application	NA	NA	
	Integra	(94-01)	Fr. Upper NA (Bolt in)	NA	NA	
	MDX	(07-13)	Fr. Lower NA RCA	NA	NA	
	NSX	(91-05)	Fr. Lower NA RSK	NA	NA	
			Rear Upper NA RCA	NA	NA	
	RDX	(07-12)	Fr. Lower NA RCA	NA	NA	
	RL 3.5L	(96-12)	Fr. Upper NA Bolt in	NA	NA	
	SLX	(96-99)	Fr. Lower NA (Bolt in)	NA	NA	
	TL 2.5L	(95-99)	Fr. Upper NA (Bolt in)	NA	NA	
			Fr. Lower applicable in Spindle		21, 06	
TL 3.2L	(99-03)	Fr. Upper NA Bolt in	NA	NA		
		NA application	NA	NA		
		Fr. Upper NA RCA	NA	NA		
TL 3.5L	(07-08)	NA application	NA	NA		
		Fr. Upper NA RCA	NA	NA		
TLX	2018	NA application	NA	NA		
Audi	A3	(06-08)	Fr. Lower NA (Bolt in)	NA	NA	
	A4	(96-04)	Rear Lower NA RCA	NA	NA	
			Fr. Lower NA RCA	NA	NA	
			Fr. Upper NA RCA	NA	NA	
			Rear Upper NA RCA	NA	NA	
	A4	(96-04)	Rear Lower NA RCA	NA	NA	
	Quattro	(96-08)	Rear Lower NA RCA	NA	NA	
			Fr. Lower NA RCA	NA	NA	
	A5	2008	Fr. Lower NA (Bolt in)	NA	NA	
			Fr. Upper NA RCA	NA	NA	
	A6	(96-04)	Rear Lower NA RCA	NA	NA	
			Rear Upper NA RCA	NA	NA	
			Fr. Lower NA RCA	NA	NA	
			Fr. Upper NA RCA	NA	NA	
	A6	Quattro	(96-04)	Rear Lower NA RCA	NA	NA
			(96-05)	Rear Upper NA RCA	NA	NA
			(96-08)	Fr. Lower NA RCA	NA	NA
	A8	(97-99)	Fr. Lower NA RCA	NA	NA	
			Rear Lower NA RCA	NA	NA	
			Rear Upper NA RCA	NA	NA	
	A8	Quattro	(97-02)	Rear Lower NA RCA	NA	NA
			(00-08)	Fr. Lower NA RCA	NA	NA
			(99-05)	Rear Upper NA RCA	NA	NA
Allroad	2005	Fr. Lower NA RCA	NA	NA		
		Rear Upper NA RCA	NA	NA		
Cabriolet	(96-98)	Fr. Lower NA (Bolt in)	NA	NA		
Q7	(07-08)	Fr. Lower NA RCA	NA	NA		
R8 Quattro	(07-15)	Fr. Lower NA RCA	NA	NA		
RS4	(06-08)	Fr. Lower NA RCA	NA	NA		
RS6	(03-04)	Fr. Lower NA RCA	NA	NA		
S4	(00-02)	Rear Lower NA RCA	NA	NA		
		Rear Upper NA RCA	NA	NA		
		Fr. Lower NA RCA	NA	NA		

Make	Model	Year	Application	Removal	Installation
Audi	S4 Avant	(04-05)	Fr. Lower NA RCA	NA	NA
	S4 Cabriolet	(04-05)	Fr. Lower NA RCA	NA	NA
	S5	(07-12)	Fr. Lower NA RCA	NA	NA
	S6	(99-03)	Fr. Upper & Lower NA RCA	NA	NA
			Rear Upper NA RCA	NA	NA
	S6 Avant	(06-11)	Fr. Lower NA RCA	NA	NA
			Fr. Upper & Lower NA RCA	NA	NA
	S8	(01-03)	Fr. Upper & Lower NA RCA	NA	NA
			Rear Upper NA RCA	NA	NA
	S8	(07-09)	Fr. Lower NA RCA	NA	NA
			Fr. Lower NA RCA	NA	NA
	TT	(00-06)	Fr. Lower NA (Bolt in)	NA	NA
			Fr. Lower NA RCA	NA	NA
	TT	(98-06)	Na application (Bolt in)	NA	NA
Fr. Lower NA RCA			NA	NA	
Quattro	(06-14)	Fr. Lower NA RCA	NA	NA	
BMW	128i	(08-11)	Fr. & Rear Lower NA RCA	NA	NA
	135i	(07-10)	Fr. & Rear Lower NA RCA	NA	NA
	323ci	(98-00)	Fr. Lower NA RCA	NA	NA
	323i	(98-00)	Fr. Lower NA RCA	NA	NA
	325ci	(01-06)	Fr. Lower NA RCA	NA	NA
	325i	(01-06)	Fr. Lower NA RCA	NA	NA
	325xi	(01-06)	Fr. Lower NA RCA	NA	NA
	328ci	(98-00)	Fr. Lower NA RCA	NA	NA
	328i	(07-13)	Fr. & Rear Lower NA RCA	NA	NA
			Fr. Lower NA RCA	NA	NA
	328xi	(07-08)	Fr. & Rear Lower NA RCA	NA	NA
	330ci	(01-06)	Fr. Lower NA RCA	NA	NA
	330i	(01-06)	Fr. Lower NA RCA	NA	NA
	330xi	(01-06)	Fr. Lower NA RCA	NA	NA
	335i	(07-15)	Fr. & Rear Lower NA RCA	NA	NA
	335xi	(07-15)	Fr. & Rear Lower NA RCA	NA	NA
	525	(04-05)	Fr. Lower NA RCA	NA	NA
	525i	(06-07)	Fr. & Rear Lower NA RCA	NA	NA
			Rear Upper NA RCA	NA	NA
	525xi	(06-07)	Fr. & Rear Lower NA RCA	NA	NA
	528i	(97-00)	Fr. Lower NA RCA	NA	NA
			Fr. Lower NA RCA	NA	NA
	528xi	(08-09)	Fr. Lower NA RCA	NA	NA
	530	(04-05)	Fr. Lower NA RCA	NA	NA
	530i	(01-03)	Fr. Lower NA RCA	NA	NA
			Fr. Lower NA RCA	NA	NA
	530xi	(06-07)	Fr. Lower NA RCA	NA	NA
	535i	(08-16)	Fr. Lower NA RCA	NA	NA
	535xi	2008	Fr. Lower NA RCA	NA	NA
	540i	(96-03)	Fr. Lower NA RCA	NA	NA
545	(04-05)	Rear Lower NA RCA	NA	NA	
550i	(06-16)	Fr. & Rear Lower NA RCA	NA	NA	
		Fr. & Rear Lower NA RCA	NA	NA	
645ci	(04-05)	Fr. & Rear Lower NA RCA	NA	NA	
		Rear Upper NA RCA	NA	NA	
645i	(04-05)	Fr. & Rear Lower NA RCA	NA	NA	
		Rear Upper NA RCA	NA	NA	
650i	(06-17)	Fr. & Rear Lower NA RCA	NA	NA	
		Rear Upper NA RCA	NA	NA	
740i	(95-01)	Fr. Lower NA RCA	NA	NA	



Model:

78197

Product Type:

GOLIATH BALL JOINT SERVICE TOOL AND MASTER ADAPTER SET

GOLIATH BALL JOINT SERVICE TOOL AND MASTER ADAPTER SET

Make	Model	Year	Application	Removal	Installation
BMW	740iL	(95-01)	Fr. Lower NA RCA	NA	NA
	745i	(02-05)	Fr. & Rear Lower NA RCA	NA	NA
			Rear Upper NA RCA	NA	NA
	745Li	(02-05)	Fr. & Rear Lower NA RCA	NA	NA
	750i	(06-17)	Fr. & Rear Lower NA RCA	NA	NA
			Rear Upper NA RCA	NA	NA
	750iL	(90-01)	Fr. Lower NA RCA	NA	NA
	750Li	(06-15)	Fr. Lower NA RCA	NA	NA
			Rear Lower & Upper NA RCA	NA	NA
	760i	(05-08)	Fr. & Rear Lower NA RCA	NA	NA
			Rear Upper NA RCA	NA	NA
	760Li	(03-08)	Fr. & Rear Upper NA RCA	NA	NA
			Rear Lower NA RCA	NA	NA
	840Ci	(92-99)	Fr. Lower NA RCA	NA	NA
	850Ci	(92-99)	Fr. Lower NA RCA	NA	NA
	Alpina B7	(01-08)	NA application	NA	NA
	M3	(01-06) (07-13)	Fr. Lower NA RCA	NA	NA
			Fr. Lower NA RCA	NA	NA
	M5	(99-03) (05-10)	Fr. & Rear Lower NA RCA	NA	NA
			Rear Upper NA RCA	NA	NA
			Fr. & Rear Lower NA RCA	NA	NA
	M6	(06-10)	Fr. & Rear Lower NA RCA	NA	NA
			Rear Upper NA RCA	NA	NA
	X3	(04-10)	Fr. Lower NA RCA	NA	NA
	X5	(00-06) (07-13)	Fr. Lower NA (Bolt in)	NA	NA
			Fr. Lower NA	NA	NA
X6	(08-14)	Fr. & Rear Lower NA RCA	NA	NA	
		Fr. Upper NA RCA	NA	NA	
Z3	(96-02)	Fr. Lower NA RCA	NA	NA	
Z4	(02-16)	Fr. Lower NA RCA	NA	NA	
Z8	(00-03)	Fr. Lower NA RCA	NA	NA	
Buick	Allure	(05-09)	Fr. Lower NA RCA	NA	NA
	Centruy	(82-05)	Fr. Lower NA (Bolt in)	NA	NA
	Enclave	(08-17)	Fr. Lower NA (Bolt in)	NA	NA
	LaCrosse	(05-09)	Fr. Lower NA (Bolt in)	NA	NA
	LeSabre	(86-05)	Fr. Lower NA (Bolt in)	NA	NA
	Lucerne	(06-11)	Fr. Lower NA RCA	NA	NA
	Park Avenue	(91-05)	Fr. Lower NA (Bolt in)	NA	NA
	Rainier	(04-07)	Fr. Lower applicable	15, 08	16, 10
			Fr. Upper applicable		12, 18, 06
	Regal	(88-04)	Fr. Lower NA (Bolt in)	NA	NA
	Rendezvous	(02-07)	Fr. Lower NA RCA	NA	NA
			Rear Upper & Lower NA RCA	NA	NA
	Riviera	(86-99)	Fr. Lower NA (Bolt in)	NA	NA
	Roadmaster	(91-96)	Fr. Upper NA (Bolt in)	NA	NA
	Skylark	(86-98)	Fr. Lower NA (Bolt in)	NA	NA
	Terraza	(05-07)	Fr. Lower NA (Bolt in)	NA	NA
			Rear Upper & Lower NA RCA	NA	NA
	Cadillac	Catera	(97-01)	Fr. Lower NA (Bolt in)	NA
Concours		(97-99)	Fr. Lower NA (Bolt in)	NA	NA
CTS		(03-13)	Fr. Lower applicable		03, 08, 10, 06
DeVille <small>(HD Suspension, Limo Commercial Chassis)</small>		(96-99)	Fr. Lower applicable	04, 03, 08, 09	03, 09
DeVille		(00-05)	Fr. Lower NA (Bolt in)	NA	NA
DHS		2004	Fr. Lower NA (Bolt in)	NA	NA
DTS		(06-11)	Fr. Lower NA RCA	NA	NA
Eldorado		(86-02)	Fr. Lower NA (Bolt in)	NA	NA

Make	Model	Year	Application	Removal	Installation
Cadillac	Escalade	(99-00) (02-07) (07-14)	Fr. Lower applicable	15, 08	09, 03, 13
			Fr. Upper NA (Bolt in)	NA	NA
			Fr. Lower applicable		10 or 09, 07, 13 or 03, 08
	Fleetwood	(91-96)	Fr. Upper NA (Bolt in)	NA	NA
			Fr. Lower NA (Bolt in)	NA	NA
	SRX	(04-09)	Fr. Lower NA RCA	NA	NA
			Fr. Upper NA	NA	NA
			Rear Upper NA RCA	NA	NA
	STS	(05-11)	Fr. Upper & Lower NA RCA	NA	NA
	STS-V (DX)	(06-09)	Fr. Lower NA RCA	NA	NA
	STS-V8 (DC)	(05-09)	Fr. Lower NA RCA	NA	NA
XLR	(04-09)	Fr. Upper & Lower NA RCA	NA	NA	
Chevrolet	C/K 1500 2WD	(91-00)	Fr. Upper NA (Bolt in)	NA	NA
	C/K 1500 4WD	(96-99)	Fr. Lower applicable	15, 08	09, 03, 13
	C/K 1500 4WD	(95-99)	Fr. Upper NA (Bolt in)	NA	NA
	C/K 2500 2WD	(91-99)	Fr. Upper NA (Bolt in)	NA	NA
	C/K 2500 2WD w/ 7200 lbs GVW	(91-92)	Fr. Lower applicable	08, 03, 04, 09, 06	
	C/K 2500 2WD w/ 8600 lbs GVW	(91-92)	Fr. Lower applicable	08, 03, 04, 09, 06	
	C/K 2500 2WD w/ 8600 lbs GVW	(91-00)	Fr. Upper NA (Bolt in)	NA	NA
	C/K 2500 4WD	(96-99)	Fr. Lower applicable	15, 08	09, 03, 13
	C/K 2500 4WD w/ 7200 lbs GVW	(95-99)	Fr. Upper NA (Bolt in)	NA	NA
	C/K 2500 4WD w/ 8600 lbs GVW	(95-00)	Fr. Upper NA (Bolt in)	NA	NA
	30 Comm	(98-00)	Fr. Lower NA	NA	NA
			Fr. Upper NA (Bolt in)	NA	NA
	30 Motor	(73-97)	Fr. Lower NA	NA	NA
			Fr. Upper NA (Bolt in)	NA	NA
	Home	(73-97)	Fr. Upper NA (Bolt in)	NA	NA
	30 Motor Home w/ IFS	(73-97)	Fr. Upper NA (Bolt in)	NA	NA
	30 Step	(73-97)	Fr. Lower NA	NA	NA
			Fr. Upper NA (Bolt in)	NA	NA
	Van	(73-97)	Fr. Upper NA (Bolt in)	NA	NA
	30 Step Van w/ IFS	(73-97)	Fr. Upper NA (Bolt in)	NA	NA
	3500 2WD w/ IFS (5th VIN digit 'C')	(91-92)	Fr. Lower applicable	08, 03, 04, 09, 06	
	3500 4WD	(91-00)	Fr. Upper NA (Bolt in)	NA	NA
			Fr. Lower applicable	15, 08	09, 03, 13
	3500 4WD	(95-00)	Fr. Upper NA (Bolt in)	NA	NA
			Fr. Lower applicable		13, 03 or 07, 09
	Astro 2WD	(85-05)	Fr. Lower applicable		
Fr. Upper NA (Bolt in)			NA	NA	
Astro 4WD	(90-05)	Fr. Lower NA (Bolt in)	NA	NA	
		Fr. Upper NA (Bolt in)	NA	NA	
Avalanche 1500 2WD/4WD	(02-13)	Fr. Lower applicable		10 or 09, 07, 13 or 03, 08	
Avalanche 2500 2WD/4WD	(02-06)	Fr. Lower applicable	15, 08	10, 13 or 03, 08	
Avalanche 2WD/ 4WD	(07-13)	Fr. Lower NA	NA	NA	
Aveo	(02-11)	Fr. Lower NA (Bolt in)	NA	NA	
		Fr. Upper NA RCA	NA	NA	
Aveo	(02-11)	Fr. Lower NA (Bolt in)	NA	NA	
Beretta	(87-96)	Fr. Lower NA (Bolt in)	NA	NA	
Blazer 2WD	(82-05)	Fr. Upper NA (Bolt in)	NA	NA	
Blazer 4WD	(82-05)	Fr. Lower NA (Bolt in)	NA	NA	
		Fr. Upper NA (Bolt in)	NA	NA	
Camaro	(93-02)	Fr. Upper NA (Bolt in)	NA	NA	
Caprice	(91-96)	Fr. Lower applicable	NA	NA	
		Fr. Upper NA (Bolt in)	NA	NA	
Cavalier	(82-05)	Fr. Lower NA (Bolt in)	NA	NA	
Cobalt	(05-10)	Fr. Lower NA (Bolt in)	NA	NA	
Colorado 2WD/4WD	(04-12)	Fr. Upper & Lower NA (Bolt in)	NA	NA	
Corsica	(87-96)	Fr. Lower NA (Bolt in)	NA	NA	
Corvette	(84-96)	Fr. Lower applicable	09, 03, 04, 08		
		Fr. Upper NA (Bolt in)	NA	NA	
		Fr. Lower NA RCA	NA	NA	
	(02-13)	Fr. Lower NA RCA	NA	NA	
	(05-13)	Fr. Upper NA RSK	NA	NA	



Model:

78197

Product Type:

GOLIATH BALL JOINT SERVICE TOOL AND MASTER ADAPTER SET

GOLIATH BALL JOINT SERVICE TOOL AND MASTER ADAPTER SET

Make	Model	Year	Application	Removal	Installation
Chevrolet	Equinox	(05-09)	Fr. Lower NA (Bolt in)	NA	NA
	Express 1500	(03-15)	Fr. Lower applicable		10 or 09, 07, 13 or 03, 08
		(96-02)	Fr. Upper NA (Bolt in)	NA	NA
		(03-14)	Fr. Lower applicable		10 or 09, 07, 13 or 03, 08
	Express 2500 w/7300 lbs GVW	(96-02)	Fr. Upper NA (Bolt in)	NA	NA
	Express 2500 w/7700 & 8600 lbs GVW	(96-02)	Fr. Upper NA (Bolt in)	NA	NA
	Express 2500 w/8500 lbs GVW	(03-14)	Fr. Lower applicable	19	10, 03, 08, 13
	Express 3500	(96-14)	Fr. Lower applicable	19	10, 03, 08, 13
	G10	(71-95)	Fr. Upper NA (Bolt in)	NA	NA
	G20	(73-95)	Fr. Upper NA (Bolt in)	NA	NA
	G30	(73-95)	Fr. Upper NA (Bolt in)	NA	NA
	HHR	(06-11)	Fr. Lower NA (Bolt in)	NA	NA
	Impala	(00-13)	Fr. Lower NA (Bolt in)	NA	NA
		(94-96)	Fr. Upper NA (Bolt in)	NA	NA
	Lumina	(90-01)	Fr. Lower NA (Bolt in)	NA	NA
	Lumina APV	(90-96)	Fr. Lower NA (Bolt in)	NA	NA
	Malibu	(97-05)	Fr. Lower NA (Bolt in)	NA	NA
		(06-08)	Fr. Lower NA RCA	NA	NA
	Malibu Classic	(04-05 & 08)	Fr. Lower NA (Bolt in)	NA	NA
	Metro	(98-01)	Fr. Lower NA RCA	NA	NA
	Monte Carlo	(95-07)	Fr. Lower NA (Bolt in)	NA	NA
	Prizm	(98-02)	Fr. Lower NA (Bolt in)	NA	NA
	S-10 2WD	(82-05)	Fr. Upper NA (Bolt in)	NA	NA
	S-10 4WD	(82-05)	Fr. Upper & Lower NA (Bolt in)	NA	NA
	Silverado 1500 2WD	(99-06)	Fr. Lower NA (Bolt in)	NA	NA
	Silverado 1500 2WD (Old Style)	2007	Fr. Lower NA (Bolt in)	NA	NA
	Silverado 1500 2WD/4WD (New Style)	2007	Fr. Lower NA RCA	NA	NA
			Fr. Upper NA RCA	NA	NA
	Silverado 1500 4WD	(99-06)	Fr. Lower applicable		10 or 09, 07, 13 or 03, 08
	Silverado 1500 4WD (Old Style)	2007	Fr. Lower applicable		10 or 09, 07, 13 or 03, 08
	Silverado 1500 HD 2WD / 4WD	(01-07)	Fr. Lower applicable	15, 08	10, 13, 03, 08
	Silverado 2500 & 2500 HD 4WD	1999	Fr. Lower applicable	15, 08	10, 13, 03, 08
	Silverado 2500 2WD	(99-00)	Fr. Lower NA (Bolt in)	NA	NA
	Silverado 2500 2WD/4WD	(01-07)	Fr. Lower applicable	15, 08	10, 13 or 03, 08
		(08-11)	Fr. Lower NA	NA	NA
			Fr. Upper NA	NA	NA
	Silverado 2500 4WD	2000	Fr. Lower applicable	15, 08	10, 13 or 03, 08
	Silverado 2500 HD 2WD / 4WD	(01-11)	Fr. Lower applicable	15, 08	10, 13 or 03, 08
	Silverado 3500 2WD / 4WD	(01-11)	Fr. Lower applicable	15, 08	10, 13 or 03, 08
	SSR	(03-06)	Fr. Lower applicable	15, 08	16, 10
			Fr. Upper applicable		12, 18, 06
	Suburban 1500 2WD	1992	Fr. Lower applicable	08, 03, 04, 09, 06	
		(92-99)	Fr. Upper NA (Bolt in)	NA	NA
	Suburban 1500 2WD/4WD	(00-06)	Fr. Lower applicable		10 or 09, 07, 13, 03, 08
		(07-14)	Fr. Lower applicable		09, 07, 08, 03, 06
		Fr. Upper NA RCA	NA	NA	
Suburban 1500 4WD	(96-99)	Fr. Lower applicable	15, 08	09, 03, 13	
	(95-99)	Fr. Upper NA (Bolt in)	NA	NA	
Suburban 2500 2WD	1992	Fr. Lower applicable	08, 03, 04, 09, 06		
	2000	Fr. Lower NA (Bolt in)	NA	NA	
Suburban 2500 2WD	(92-99)	Fr. Upper NA (Bolt in)	NA	NA	
Suburban 2500 2WD/4WD	(01-13)	Fr. Lower applicable	15, 08	10, 13 or 03, 08	
Suburban 2500 4WD	(96-99)	Fr. Lower applicable	15, 08	09, 03, 13	
	2000	Fr. Lower applicable	15, 08	10, 13 or 03, 08	
	(95-99)	Fr. Upper NA (Bolt in)	NA	NA	
Suburban 4WD	(96-97)	Fr. Upper NA (Bolt in)	NA	NA	
Tahoe 2WD	(95-99)	Fr. Upper NA (Bolt in)	NA	NA	
Tahoe 2WD New Style (Exc. Limited)	2000	Fr. Lower applicable		10, 09 or 07, 13 or 03, 08	
Tahoe 2WD Old Style Limited	2000	Fr. Upper NA (Bolt in)	NA	NA	

Make	Model	Year	Application	Removal	Installation
Chevrolet	Tahoe 2WD/4WD	(01-06)	Fr. Lower applicable		10 or 09, 07, 13 or 03, 08
		(07-14)	Fr. Lower applicable		09, 07, 08, 03, 06
			Fr. Upper NA RCA	NA	NA
	Tahoe 4WD	(96-00)	Fr. Lower applicable	15, 08	09, 03, 13
		(95-00)	Fr. Upper NA (Bolt in)	NA	NA
	Tahoe 4WD New Style (Exc. Z71)		Fr. Lower applicable		
	Tahoe 4WD Old Style Z71	2000	Fr. Upper NA (Bolt in)	NA	NA
	Tracker	(99-04)	Fr. Lower NA RCA	NA	NA
	Tracker 2WD/4WD	1998	Fr. Lower NA (Bolt in)	NA	NA
	Trailblazer 2WD/4WD	(02-09)	Fr. Upper applicable		12, 18, 06
			Fr. Lower applicable	15, 08	16, 10
	Trailblazer EXT 2WD/4WD	(03-07)	Fr. Upper applicable	15, 08	16, 10
			Fr. Lower applicable		12, 18, 06
	Uplander	(05-08)	Fr. Lower NA (Bolt in)	NA	NA
			Rear Upper & Lower NA RCA	NA	NA
Venture	(97-05)	Fr. Lower NA (Bolt in)	NA	NA	
	(02-05)	Rear Upper & Lower NA RCA	NA	NA	
Venture 2WD/4WD	(02-05)	Fr. Lower NA (Bolt in)	NA	NA	
Chrysler	300C AWD	(05-10)	Fr. Upper and Lower NA RCA	NA	NA
	300C RWD	(05-10)	Fr. Lower applicable		16, 10
			Fr. Upper NA RCA	NA	NA
	300M	(99-04)	Fr. Lower NA RCA	NA	NA
	Aspen 2WD/4WD	(07-09)	Fr. Lower applicable		08, 03 or 13, 07, 09, 06
			Fr. Upper NA RCA	NA	NA
	Cirrus	(95-00)	Fr. Lower NA RCA	NA	NA
	Concorde	(93-04)	Fr. Lower NA RCA	NA	NA
	Crossfire	(04-08)	Fr. Upper NA RCA	NA	NA
			Fr. Lower NA (Bolt in)	NA	NA
	Grand Voyager	2000	Fr. Lower applicable	12, 18 or 02, 09	
	LHS	(94-01)	Fr. Lower NA RCA	NA	NA
	New Yorker	(94-96)	Fr. Lower NA RCA	NA	NA
	Pacifica	2004	Fr. Lower NA RCA	NA	NA
	Pacifica FWD/4WD	(05-08)	Fr. Lower applicable	12, 18	
Prowler	(97-02)	Fr. Upper & Lower NA RCA	NA	NA	
		Rear Lower NA RCA	NA	NA	
Sebring Convertible	(96-06)	Fr. Lower NA RCA	NA	NA	
Sebring Coupe	(95-00)	Fr. Lower NA RCA	NA	NA	
		Fr. Upper NA (Bolt in)	NA	NA	
Sebring Sedan	(01-06)	Fr. Lower NA RCA	NA	NA	
Town & Country	(90-00)	Fr. Lower applicable	12, 18 or 02, 09	21, 08	
	(01-16)	Fr. Lower applicable	12, 18		
Voyager	(00-03)	Fr. Lower applicable	12, 18 or 02, 09	21, 08	
Dodge	Lanos	(97-02)	Fr. Lower NA (Bolt in)	NA	NA
			Fr. Upper NA (Bolt in)	NA	NA
	Leganza	(99-02)	Fr. Lower NA (Bolt in)	NA	NA
	Nubira	(97-02)	Fr. Lower NA (Bolt in)	NA	NA
	Avenger	(95-00)	Fr. Lower NA RCA	NA	NA
Dodge	Caliber FWD/4WD	(07-12)	Fr. Lower applicable	12, 18	
		(84-00)	Fr. Lower applicable	12, 18 or 02, 09	21, 08
		(01-06)	Fr. Lower applicable	12, 18	
		(07-17)	Fr. Lower NA RCA	NA	NA
	Challenger	(08-10)	Fr. Lower applicable		16, 10
	Charger AWD	(06-10)	Fr. Upper & Lower NA RCA	NA	NA
	Charger RWD	(06-10)	Fr. Lower applicable		16, 10
		Fr. Upper NA RCA	NA	NA	
Colt	(84-94)	Fr. Lower applicable	12, 18	16	
Colt Vista	1996	Fr. Lower NA RCA	NA	NA	
Dakota 2WD	(87-96)	Fr. Upper NA (Screw in)	NA	NA	
	(97-99)	Fr. Lower NA (Bolt in)	NA	NA	



Model:

78197

Product Type:

GOLIATH BALL JOINT SERVICE TOOL AND MASTER ADAPTER SET

GOLIATH BALL JOINT SERVICE TOOL AND MASTER ADAPTER SET

Make	Model	Year	Application	Removal	Installation
Dodge	Dakota 2WD	(00-04)	Fr. Lower NA (Bolt in)	NA	NA
			Fr. Upper NA (Bolt in)	NA	NA
		(97-99)	Fr. Upper NA (Bolt in)	NA	NA
	Dakota 2WD/4WD	(05-11)	Fr. Lower applicable		10, 13
			Fr. Upper NA RCA	NA	NA
	Dakota 4WD	(97-04)	Fr. Lower applicable	08, 03 or 13	16, 07, 09
			Fr. Upper NA (Bolt in)	NA	NA
	Durango 2WD	(99-03)	Fr. Upper & Lower NA (Bolt in)	NA	NA
			Fr. Lower applicable		08, 03 or 13, 07, 09, 06
	Durango 2WD/4WD	(04-09)	Fr. Upper NA RCA	NA	NA
			Fr. Lower applicable		
	Durango 4WD	(98-03)	Fr. Lower applicable	08, 03 or 13	16, 07, 09
			Fr. Upper NA (Bolt in)	NA	NA
	Grand Caravan	(88-00)	Fr. Lower applicable	12, 18 or 02, 09	
			Fr. Lower applicable	12, 18	
	Intrepid	(08-10)	Fr. Lower NA RCA	NA	NA
			Fr. Lower NA RCA	NA	NA
	Magnum AWD	(93-04)	Fr. Lower NA RCA	NA	NA
			Fr. Lower NA RCA	NA	NA
	Magnum RWD	(05-08)	Fr. Lower NA RCA	NA	NA
			Fr. Upper NA RCA	NA	NA
	Nitro 2WD/4WD	(07-12)	Fr. Lower applicable		16, 10
			Fr. Upper NA RCA	NA	NA
	Ram 1500 2WD	(94-96)	Fr. Lower applicable	04, 08	09, 07, 16
			Fr. Lower applicable	04, 08	09, 07, 16
			Fr. Lower NA (Bolt in)	NA	NA
	Ram 1500 2WD	(00-01)	Fr. Upper NA (Bolt in)	NA	NA
			Fr. Upper NA (Bolt in)	NA	NA
	Ram 1500 2WD HD	2006	Fr. Lower NA	NA	NA
	Ram 1500 2WD HD	2008	Fr. Upper NA	NA	NA
	Ram 1500 2WD Light Duty w/FS	(07-09)	Fr. Upper & Lower NA	NA	NA
	Ram 1500 2WD/4WD	(02-05)	Fr. Lower applicable		10, 03, 08
			Fr. Upper NA RCA	NA	NA
Ram 1500 4WD	(94-99)	Fr. Lower applicable	12, 20 or 21	18, 11	
		Fr. Upper applicable	20, 12	18, 11	
	2006	Fr. Lower applicable		10, 03, 08	
Ram 1500 4WD HD	(07-08)	Fr. Lower NA	NA	NA	
Ram 1500 4WD Light Duty w/FS	(07-08)	Fr. Lower NA	NA	NA	
Ram 1500 4WD w/216 FBI Axle	(00-01)	Fr. Upper applicable	20, 12	18, 11	
		Fr. Lower applicable	12, 20 or 21	18, 11	
Ram 1500 4WD w/248 FBI Axle	(00-01)	Fr. Upper applicable	20, 12	18, 11	
		Fr. Lower applicable	12, 20 or 21	18, 11	
Ram 2500 2WD	(94-99)	Fr. Lower applicable	04, 08	09, 07, 16	
		Fr. Lower NA (Bolt in)	NA	NA	
		Fr. Lower applicable	19	10, 03, 08, 13	
		Fr. Upper NA (Bolt in)	NA	NA	
		Fr. Upper NA RCA	NA	NA	
Ram 2500 4WD	(06-08)	Fr. Upper NA	NA	NA	
		Fr. Upper NA	NA	NA	
Ram 2500 4WD w/ Dana 44 Axle	(00-08)	Fr. Upper applicable	09, 03	NA	
		Fr. Lower applicable	12, 20 or 21	18, 11	
Ram 2500 4WD w/ Dana 60 (4500 lb axle)	(96-99)	Fr. Upper applicable	20, 12	18, 11	
		Fr. Lower applicable	03 or 08, 17	08, 02, 10	
Ram 3500 2WD	(94-99)	Fr. Lower applicable	08, 17	16, 10 or 07, 09	
		Fr. Upper NA	19	10, 03, 08, 13	
		Fr. Upper NA	NA	NA	
Ram 3500 2WD w/FS	(03-05)	Fr. Upper NA	NA	NA	
		Fr. Upper NA	NA	NA	
Ram 3500 2WD w/Solid Fr. Axle	(06-08)	Fr. Upper NA	NA	NA	
		Fr. Lower applicable	04, 08	09, 07, 16	
Ram 3500 2WD w/IFS	(94-99)	Fr. Lower applicable	04, 08	09, 07, 16	
		Fr. Upper applicable	09, 03	NA	
Ram 3500 2WD w/IFS	(00-02)	Fr. Upper NA (Bolt in)	NA	NA	
Ram 3500 2WD w/IFS	(00-02)	Fr. Upper NA (Bolt in)	NA	NA	

Make	Model	Year	Application	Removal	Installation
Dodge	Ram 3500 4WD	(96-99)	Fr. Upper applicable	03 or 08, 17	08, 02, 10
			Fr. Lower applicable	08, 17	16, 10 or 07, 09
		(00-08)	Fr. Upper applicable	08, 03	
	Ram 3500 4WD w/Solid Fr. Axle	(94-99)	Fr. Upper applicable	03 or 08, 17	08, 02, 10
			Fr. Lower applicable	08, 17	16, 10 or 07, 09
	Ram SRT-10	(04-06)	Fr. Lower applicable		10, 03, 08
	Ram Van 1500	(95-03)	Fr. Upper NA RCA	NA	NA
			Fr. Upper NA	NA	NA
	Ram Van 2500	(95-03)	Fr. Lower applicable		08, 03, 10
			Fr. Upper NA	NA	NA
	Ram Van 3500 w/3600 lbs Axle	(95-03)	Fr. Lower applicable		08, 03, 10
			Fr. Upper NA	NA	NA
	Ram Van 3500 w/4000 lbs Axle	(95-03)	Fr. Lower applicable		08, 03, 10
			Fr. Upper NA	NA	NA
	Ram Van B100 (Standard Suspension)	(71-80)	Fr. Upper NA	NA	NA
	Ram Van B100 (HD Suspension)	(72-80)	Fr. Upper NA	NA	NA
	Ram Van B150 (Standard Suspension)	(81-94)	Fr. Upper NA	NA	NA
	Ram Van B150 (HD Suspension)	(81-94)	Fr. Lower applicable		08, 03, 10
	Ram Van B150 (Standard Suspension)	(71-80)	Fr. Upper NA	NA	NA
	Ram Van B200 (HD Suspension)	(72-80)	Fr. Lower applicable		08, 03, 10
	Ram Van B200 (Standard Suspension)	(72-80)	Fr. Upper NA	NA	NA
	Ram Van B250 (Standard Suspension)	(81-94)	Fr. Upper NA	NA	NA
	Ram Van B250 (HD Suspension)	(81-94)	Fr. Lower applicable		08, 03, 10
	Ram Van B300 (Standard Suspension)	(71-80)	Fr. Upper NA	NA	NA
	Ram Van B300 (HD Suspension)	(71-80)	Fr. Lower applicable		08, 03, 10
	Ram Van B350 (Standard Suspension)	(81-94)	Fr. Upper NA	NA	NA
	Ram Van B350 (HD Suspension)	(81-94)	Fr. Lower applicable		08, 03, 10
	Ram Wagon 1500	(99-03)	NA application	NA	NA
	Ram Wagon 2500	(99-03)	NA application	NA	NA
	Ram Wagon 3500	(99-03)	NA application	NA	NA
	Sprinter 2500	(03-10)	Fr. Lower applicable	14, 08	10, 03, 08, 13
	Sprinter 3500	(03-10)	Fr. Lower applicable	14, -08	10, 03, 08, 13
	Stealth	1996	Fr. Lower NA RCA	NA	NA
Stratus	(95-00)	Fr. Lower NA RCA	NA	NA	
		Fr. Lower NA RCA	NA	NA	
Stratus Sedan	(01-06)	Fr. Lower NA RCA	NA	NA	
Viper	(97-17)	Fr. Lower NA RCA	NA	NA	
		Fr. Upper NA	NA	NA	
Eagle	2000 GTX (Canada Only)	(91-93)	Fr. Lower applicable	12, 18	16
			Fr. Lower applicable	12, 18	16
	Summit	(90-94)	Fr. Lower applicable	12, 18	16
			Fr. Lower NA RCA	NA	NA
	Talon	(95-98)	Fr. Upper NA (Bolt in)	NA	NA
Fr. Lower NA RCA			NA	NA	
Vision	(93-97)	Fr. Lower NA RCA	NA	NA	
Ford	Aerostar 2WD	(86-97)	Fr. Upper NA (Bolt in)	NA	NA
			Fr. Lower applicable		08, 03
	Aerostar 4WD	(86-97)	Fr. Lower applicable	08, 03 or 13	10, 08, 02
			Fr. Upper NA (Bolt in)	NA	NA
	Aspire	(96-97)	Fr. Lower NA RCA	NA	NA
	Bronco	(80-96)	Fr. Lower NA RCA	NA	NA
			Fr. Lower applicable	16	21, 10
	Bronco II 4WD w/ Dana 28 Axle	(84-90)	Fr. Upper applicable	16	21 or 08, 02, 10
			Fr. Lower applicable	08, 03	08, 02, 10 or 07, 09
	Bronco II 4WD w/ Dana 35 Axle	1990	Fr. Upper applicable	08, 03	08, 02, 10 or 07, 09
Fr. Lower applicable			08, 03	08, 02, 10 or 07, 09	
Contour	(95-00)	Fr. Lower NA (Bolt in)	NA	NA	



Model:

78197

Product Type:

GOLIATH BALL JOINT SERVICE TOOL AND MASTER ADAPTER SET

GOLIATH BALL JOINT SERVICE TOOL AND MASTER ADAPTER SET

Make	Model	Year	Application	Removal	Installation
Ford	Crown Victoria	(03-08)	Fr. Lower applicable	19	
		(95-02)	Fr. Lower applicable		20, 10, 06
	E-150	(92-04)	Fr. Lower applicable	13 or 08, 03	08, 02, 10
		(03-08)	Fr. Lower applicable	08, 14	08, 02, 10
		(96-02)	Fr. Upper applicable	08, 17	08, 02, 10
		(03-08)	Fr. Upper applicable	08, 03 or 13	08, 02, 10
	E-250,	(96-04)	Fr. Lower applicable	19	16, 10 or 07, 09
	E-350,	(05-08)	Fr. Lower applicable	08, 04 or 19	16, 10 or 07, 09
	E-450	(96-04)	Fr. Upper applicable	08, 17	08, 02, 10
		(05-08)	Fr. Upper applicable	08, 03 or 13	08, 02, 10
	E-550	(02-03)	No Ball Joint applicable	NA	NA
	Edge	(07-17)	Fr. Lower NA RCA	NA	NA
	Escort	(84-90)	Fr. Lower NA RCA	NA	NA
		(91-02)	Fr. Lower NA (Bolt in)	NA	NA
	Excursion 2WD	(00-05)	Fr. Upper applicable	16	21 or 08, 02, 10
			Fr. Lower applicable	08, 17	16, 10
	Excursion 4WD	(00-05)	Fr. Upper applicable	16 or 13	21, 10
			Fr. Lower applicable	08, 17	16, 10
	EXP	(82-88)	Fr. Lower NA RCA	NA	NA
	Expedition 2WD/4WD	(97-02)	Fr. Lower applicable	19 or 04, 08	10, 03, 08
		(03-17)	Fr. Lower applicable	7897-19	10, 03, 08 or 13
	Explorer 2WD/4WD	(96-05)	Fr. Lower applicable	19 or 04, 08	10, 03, 08 or 13
		(02-05)	Rear Lower NA	NA	NA
		(06-10)	Fr. Lower NA RCA	NA	NA
		(95-00)	Fr. Upper NA RCA	NA	NA
	Explorer 4WD w/ Dana 28 Axle	(91-94)	Fr. Lower applicable	08, 03	08, 02, 10 or 07, 09
			Fr. Upper applicable	08, 03	08, 02, 10 or 07, 09
	Explorer 4WD w/ Dana 35 Axle	(91-93)	Fr. Lower applicable	08, 03	08, 02, 10 or 07, 09
		(93-94)	Fr. Lower applicable	08, 03	08, 02, 10 or 07, 09
		(91-93)	Fr. Upper applicable	08, 03	08, 02, 10 or 07, 09
		(93-94)	Fr. Upper applicable	08, 03	08, 02, 10 or 07, 09
	Explorer Sport Trac 2WD/4WD	(02-05)	Rear Lower NA	NA	NA
		(04-05)	Fr. Lower applicable	19 or 04, 08	10, 03, 08
		(07-10)	Fr. Lower NA RCA	NA	NA
		(04-05)	Fr. Upper NA RCA	NA	NA
	Explorer Sport/ Sport Trac 2WD/4WD	2001	Fr. Lower applicable	19 or 04, 08	10, 03, 08
		(02-03)	Fr. Lower applicable	19 or 04, 08	10, 03, 08
		2001	Fr. Upper NA RCA	NA	NA
	F-150 2WD	(87-96)	Fr. Lower applicable	08, 03	08, 02, 10
		(87-97)	Fr. Upper applicable in Spindle	16	08, 02, 10
		(97-03)	Fr. Upper NA RCA	NA	NA
	F-150 2WD/4WD	(97-03)	Fr. Lower applicable	19 or 04, 08	10, 03, 08
		(04-08)	Fr. Lower applicable	19	10, 03, 08 or 13
		(97-03)	Fr. Upper NA RCA	NA	NA
	F-150 2WD/4WD (Base)	2008	Fr. Lower NA RCA	NA	NA
	F-150 2WD/4WD (HD)	2008	Fr. Lower NA RCA	NA	NA
	F-150 4WD	(80-96)	Fr. Lower applicable	16	21, 10
(97-03)		Fr. Upper applicable	16	21 or 08, 02, 10	
F-150 Heritage & Lightning	2004	Fr. Lower applicable	19 or 04, 08	10, 03, 08 or 13	
	2004	Fr. Upper NA RCA	NA	NA	
F250 2WD	(87-96)	Fr. Lower applicable in Spindle	08, 03	16, 10 or 07, 09	
		Fr. Upper applicable in Spindle	16	08, 02, 10	
		Fr. Lower applicable in Spindle	08, 03	16, 10 or 07, 09	
F250 2WD HD w/ Twin I-Beam	1997	Fr. Upper applicable in Spindle	16	08, 02, 10	

Make	Model	Year	Application	Removal	Installation
Ford	F250 4WD (Under 8500 lbs. GVW)	(97-99)	Fr. Lower applicable	19 or 04, 08	10, 03, 08 or 13
			Fr. Upper NA RCA	NA	NA
	F250 4WD w/ 3850 lbs. Axle	(80-96)	Fr. Lower applicable (NA on 4.10 Ratio)	16	21, 10
	VF250 4WD w/ 4600 lbs. Axle	(80-96)	Fr. Lower applicable	08, 17 or 13	16, 10
	F250 4WD HD w/ Twin I-Beam	(80-96)	Fr. Upper applicable	16	21 or 08, 02, 10
	F250 4WD w/ 4600 lbs. Axle w/ Twin I-Beam	1997	Fr. Upper applicable	16	21 or 08, 02, 10
			Fr. Lower applicable	08, 17 or 13	16, 10
	F250 Super Duty 2WD w/ Twin I-Beam Axle	(99-08)	Fr. Upper applicable	16	21 or 08, 02, 10
	F250 Super Duty 2WD/4WD (Monobeam Axle)	(99-08)	Fr. Lower applicable	08, 17	16, 10
			Fr. Upper applicable	16 or 13	21, 10
	F-350 2WD	(87-97)	Fr. Upper applicable in Spindle	16	08, 02, 10
			Fr. Lower applicable in Spindle	08, 03	16, 10 or 07, 09
	F-350 4WD (Monobeam Axle)	(92-97)	Fr. Upper applicable	16 or 13	21, 10
			Fr. Lower applicable	08, 17	16, 10
	F-350 SD 2WD w/ Twin I-Beam Axle	(99-08)	Fr. Upper applicable	16	21 or 08, 02, 10
			Fr. Lower applicable	08, 17	16, 10
	F-350 SD 2WD/4WD (Monobeam Axle)	(99-08)	Fr. Upper applicable	16 or 13	21, 10
			Fr. Lower applicable	08, 17	16, 10
			Fr. Upper applicable	16 or 13	21, 10
			Fr. Lower applicable	08, 17	16, 10
	F-450 SD 2WD/4WD	(05-08)	Fr. Upper applicable	08, 15, 06	16, 07, 09, 06
	F53	(96-97)	NA application	NA	NA
	F-550 SD 2WD/4WD (Monobeam Axle)	(99-08)	Fr. Upper applicable	16 or 13	21, 10
			Fr. Lower applicable	08, 17	16, 10
	F-550 SD 2WD/4WD	(05-08)	Fr. Upper applicable	08, 15, 06	16, 07, 09, 06
	Five Hundred	(05-07)	Fr. Lower NA RCA	NA	NA
	Focus	(98-11)	Fr. Lower NA RCA	NA	NA
	Freestar	(04-07)	Fr. Lower NA RCA	NA	NA
	Freestyle	(05-07)	NA application	NA	NA
	Fusion	(06-12)	Fr. Lower NA RCA	NA	NA
	Mustang	(94-04)	Fr. Lower applicable		20, 10
			Fr. Lower applicable	12, 03, 09	
	Probe	(89-97)	Fr. Lower applicable		16, 10
			Fr. Upper applicable	08, 03	21, 10
	Ranger 2WD	(89-97)	Fr. Lower applicable	08, 03	08, 02, 10
			Fr. Upper applicable	19	10, 03, 08 or 13
	Ranger 2WD w/ Coil Spring Suspension	(98-11)	Fr. Lower applicable	NA	NA
			Fr. Upper NA RCA	NA	NA
			Fr. Upper NA RCA	NA	NA
	Ranger 2WD/4WD w/ Torsion Bar Suspension	(98-11)	Fr. Lower applicable	19 or 04, 08	10, 03, 08
			Fr. Upper NA RCA	NA	NA
	Ranger 4WD w/ Dana 28 Axle	(83-97)	Fr. Upper applicable	08, 03	08, 02, 10
			Fr. Lower applicable	08, 03	08, 02, 10 or 07, 09
	Ranger 4WD w/ Dana 35 Axle	(90-97)	Fr. Upper applicable	08, 03	08, 02, 10 or 07, 09
			Fr. Lower applicable	08, 03	08, 02, 10 or 07, 09
	Taurus	(86-95)	Fr. Lower NA RCA	NA	NA
			Fr. Lower NA RCA	NA	NA
Taurus X	(08-09)	Fr. Lower NA RCA	NA	NA	
Tempo	(84-94)	Fr. Lower NA RCA	NA	NA	
Thunderbird	(02-05)	Fr. Upper & Lower NA RCA	NA	NA	
		Fr. Upper NA RCA	NA	NA	
Windstar	(94-03)	Fr. Lower NA RCA	NA	NA	
XZ2	(97-03)	Fr. Lower NA (Bolt in)	NA	NA	
Geo Metro	(89-97)	Fr. Lower NA RCA	NA	NA	
		Fr. Lower NA (Bolt in)	NA	NA	
Prizm	(93-97)	Fr. Lower NA (Bolt in)	NA	NA	
		Fr. Lower NA (Bolt in)	NA	NA	
Tracker 2WD/4WD	(89-98)	Fr. Lower NA (Bolt in)	NA	NA	
		Fr. Lower NA (Bolt in)	NA	NA	
GMC 1500 2WD	(91-92)	Fr. Lower applicable	08, 03, 04, 09, 06		
		Fr. Upper NA (Bolt in)	NA	NA	
		Fr. Lower applicable	15, 08	09, 03, 13	
GMC 1500 4WD	(96-99)	Fr. Lower applicable	15, 08	09, 03, 13	
		Fr. Upper NA (Bolt in)	NA	NA	
GMC 2500 2WD w/ 7200 lbs GVW	(91-92)	Fr. Lower applicable	08, 03, 04, 09, 06		



Model:

78197

Product Type:

GOLIATH BALL JOINT SERVICE TOOL AND MASTER ADAPTER SET

GOLIATH BALL JOINT SERVICE TOOL AND MASTER ADAPTER SET

Make	Model	Year	Application	Removal	Installation	
GMC	2500 2WD w/ 7200 lbs GVW	(91-00)	Fr. Upper NA (Bolt in)	NA	NA	
	2500 2WD w/ 8600 lbs GVW	(91-92)	Fr. Lower applicable	08, 03, 04 09, 06		
		(91-00)	Fr. Upper NA (Bolt in)	NA	NA	
	2500 4WD	(96-00)	Fr. Lower applicable	15, 08	09, 03, 13	
		2000	Fr. Lower NA (Bolt in)	NA	NA	
		2500 4WD w/ 7200 lbs GVW	(95-00)	Fr. Upper NA (Bolt in)	NA	NA
		2500 4WD w/ 8600 lbs GVW	(95-00)	Fr. Upper NA (Bolt in)	NA	NA
		3500 2WD w/ IFS (8th VIN digit 'C')	(91-92)	Fr. Lower applicable	08, 03, 04 09, 06	
			(91-00)	Fr. Upper NA (Bolt in)	NA	NA
		3500 4WD	(96-00)	Fr. Lower applicable	15, 08	09, 03, 13
			(95-00)	Fr. Upper NA (Bolt in)	NA	NA
		3500 Motor Home	(73-97)	Fr. Lower NA	NA	NA
				Fr. Upper NA (Bolt in)	NA	NA
		3500 Motor Home w/IFS	(73-97)	Fr. Upper NA (Bolt in)	NA	NA
		3500 Step Van	(73-97)	Fr. Lower NA	NA	NA
				Fr. Upper NA (Bolt in)	NA	NA
		3500 Step Van w/ IFS	(73-97)	Fr. Upper NA (Bolt in)	NA	NA
		Acadia	(07-17)	Fr. Lower NA (Bolt in)	NA	NA
		Canyon 2WD/4WD	(04-12)	Fr. Upper & Lower NA (Bolt in)	NA	NA
		Envoy 2WD/4WD	(98-00)	Fr. Upper & Lower NA (Bolt in)	NA	NA
			(02-09)	Fr. Upper applicable		12, 18, 06
				Fr. Lower applicable	15, 08	16, 10
		G1500	(71-95)	Fr. Upper NA (Bolt in)	NA	NA
		G2500	(73-95)	Fr. Upper NA (Bolt in)	NA	NA
		G3500	(73-96)	Fr. Upper NA (Bolt in)	NA	NA
		Jimmy 2WD	(82-02)	Fr. Upper NA (Bolt in)	NA	NA
		Jimmy 4WD	(82-02)	Fr. Upper & Lower NA (Bolt in)	NA	NA
		S-15 Sonoma 2WD	(82-04)	Fr. Upper NA (Bolt in)	NA	NA
		S-15 Sonoma 4WD	(82-04)	Fr. Upper & Lower NA (Bolt in)	NA	NA
		Safari 2WD	(85-05)	Fr. Lower applicable		13, 03 or 07, 09
				Fr. Upper NA (Bolt in)	NA	NA
		Safari 4WD	(90-05)	Fr. Upper & Lower NA (Bolt in)	NA	NA
		Savana 1500	(96-02)	Fr. Upper NA (Bolt in)	NA	NA
			(03-15)	Fr. Lower applicable		10 or 09, 07, 13 or 03, 08
		Savana 2500 w/7300 lbs. GVW	(03-17)	Fr. Lower applicable		10 or 09, 07, 13 or 03, 08
			(96-02)	Fr. Upper NA (Bolt in)	NA	NA
		Savana 2500 w/7700 & 8600 lbs. GVW	(96-02)	Fr. Upper NA (Bolt in)	NA	NA
		Savana 2500 w/8500 & 8600 lbs. GVW	(03-17)	Fr. Lower applicable	19	10, 03, 08 or 13
		Savana 3500	(03-17)	Fr. Lower applicable	19	10, 03, 08 or 13
		Sierra 1500 2WD	(96-02)	Fr. Upper NA (Bolt in)	NA	NA
		Sierra 1500 4WD	(99-07)	Fr. Lower NA (Bolt in)	NA	NA
				Fr. Lower applicable		10 or 09, 07, 13 or 03, 08
		Sierra 1500 HD 2WD/4WD	(00-07)	Fr. Lower applicable	15, 08	10, 13 or 03, 08
		Sierra 2500 2WD/4WD	(01-04)	Fr. Lower applicable	15, 08	10, 13 or 03, 08
		Sierra 2500 4WD	(99-00)	Fr. Lower applicable	15, 08	10, 13 or 03, 08
			Fr. Upper NA (Bolt in)	NA	NA	
	Sierra 2500 HD 2WD/4WD	(01-11)	Fr. Lower applicable	15, 08	10, 13 or 03, 08	
	Sierra 3500 2WD/4WD	(01-11)	Fr. Lower applicable	15, 08	10, 13 or 03, 08	
	Sierra Denali	(02-07)	Fr. Lower applicable		10 or 09, 07, 13 or 03, 08	
	Suburban 1500 2WD	1992	Fr. Lower applicable	08, 03, 04 09, 06		
		(92-99)	Fr. Upper NA (Bolt in)	NA	NA	
	Suburban 1500 4WD	(96-99)	Fr. Lower applicable	15, 08	09, 03, 13	
		(95-99)	Fr. Upper NA (Bolt in)	NA	NA	
	Suburban 2500 2WD	1992	Fr. Lower applicable	08, 03, 04 09, 06		
		(92-99)	Fr. Upper NA (Bolt in)	NA	NA	
	Suburban 2500 4WD	(96-99)	Fr. Lower applicable	15, 08	09, 03, 13	
		(95-99)	Fr. Upper NA (Bolt in)	NA	NA	
	Syclone	1991	Fr. Upper & Lower NA (Bolt in)	NA	NA	
	Typhoon	(91-93)	Fr. Upper & Lower NA (Bolt in)	NA	NA	

Make	Model	Year	Application	Removal	Installation	
GMC	Yukon 2WD/4WD	(01-07)	Fr. Lower applicable		10 or 09, 07, 13 or 03, 08	
		(95-99)	Fr. Upper NA (Bolt in)	NA	NA	
	Yukon 4WD	(96-99)	Fr. Lower applicable	15, 08	09, 03, 13	
	Yukon 4WD w/ 5.7L	2000	Fr. Lower applicable	15, 08	09, 03, 13	
		2000	Fr. Upper NA (Bolt in)	NA	NA	
	Yukon Denali	(99-00)	Fr. Lower applicable		10 or 09, 07, 13 or 03, 08	
	Yukon Denali & Denali XL	(01-05)	Fr. Lower applicable		10 or 09, 07, 13 or 03, 08	
	Yukon exc. 5.7L	2000	Fr. Lower applicable		10 or 09, 07, 13 or 03, 08	
	Yukon XL 1500	(00-07)	Fr. Lower applicable		10 or 09, 07, 13 or 03, 08	
	Yukon XL 2500	(00-08)	Fr. Lower applicable	15, 08	10, 13 or 03, 08	
	Honda	Accord	(90-93)	Fr. Upper NA (Bolt in)	NA	NA
			(90-97)	Fr. Lower applicable in Spindle		21, 06
				Rear Upper NA RCA	NA	NA
		Accord Sedan & Coupe	(98-02)	Fr. Lower applicable in Spindle		21, 06
		Civic	(06-11)	Fr. Lower NA (Bolt in)	NA	NA
			(92-00)	Fr. Upper NA (Bolt in)	NA	NA
			(96-00)	Fr. Upper NA RCA	NA	NA
		CR-V	(07-11)	Fr. Lower NA (Bolt in)	NA	NA
		Fit	(01-08)	Fr. Lower NA RCA	NA	NA
		Insight	(00-06)	Fr. Lower NA RCA	NA	NA
		Odyssey	(95-98)	Fr. Lower applicable		21, 06
			(99-06)	Fr. Lower applicable	12, 18	
			(07-10)	Fr. Lower NA RCA	NA	NA
		Passport 2WD/4WD	(94-02)	Fr. Upper & Lower NA (Bolt in)	NA	NA
		Pilot	(07-08)	Fr. Lower NA RCA	NA	NA
Prelude		(00-01)	Fr. Lower NA RCA	NA	NA	
		(92-96)	Fr. Upper NA (Bolt in)	NA	NA	
		(92-99)	Fr. Lower applicable		21, 06	
		1996	Fr. Upper NA (Bolt in)	NA	NA	
Prelude exc. SH		(97-01)	Fr. Upper NA (Bolt in)	NA	NA	
Prelude SH	(97-01)	Fr. Upper NA (Bolt in)	NA	NA		
Ridgeline	(06-14)	Fr. Lower NA RCA	NA	NA		
S2000	(00-09)	Fr. Lower NA (Bolt in)	NA	NA		
		Rear Lower NA RSK	NA	NA		
		Fr. & Rear Upper NA RCA	NA	NA		
Hummer	H1	(92-06)	NA application	NA	NA	
	H2	(03-09)	Fr. Lower applicable	15, 08	10, 13 or 03, 08	
	H3	(06-10)	NA application	NA	NA	
Hyundai	Accent	(06-11)	Fr. Lower NA (Bolt in)	NA	NA	
	Azera	(06-11)	Fr. Upper & Lower NA (Bolt in)	NA	NA	
	Elantra	(07-10)	Fr. Lower NA (Bolt in)	NA	NA	
	Entourage	(06-10)	Fr. Lower NA (Bolt in)	NA	NA	
	Ioniq	2017	NA application	NA	NA	
	Santa Fe	(01-06)	Rear Lower NA RCA	NA	NA	
	Sonata	(99-10)	Fr. Upper & Lower NA (Bolt in)	NA	NA	
	Tucson	(05-10)	Fr. Lower NA (Bolt in)	NA	NA	
	Veracruz	(07-12)	Fr. Lower NA (Bolt in)	NA	NA	
	XG300	2001	Fr. Lower NA (Bolt in)	NA	NA	
XG350	(02-05)	Fr. Lower NA (Bolt in)	NA	NA		
Infiniti	EX35	(07-12)	Fr. Lower NA RCA	NA	NA	
			Fr. & Rear Upper NA RCA	NA	NA	
	FX35	(03-12)	Fr. Lower NA RCA	NA	NA	
			Rear Upper NA RCA	NA	NA	
	FX45	(03-08)	Fr. Lower NA RCA	NA	NA	
			Rear Upper NA RCA	NA	NA	
FX50	(09-13)	Fr. Lower NA RCA	NA	NA		
		Rear Upper NA RCA	NA	NA		
G20	(91-96)	Fr. Lower applicable	12, 18			
	(99-02)	Rear Upper NA RCA	NA	NA		



Model:

78197

Product Type:

GOLIATH BALL JOINT SERVICE TOOL AND MASTER ADAPTER SET

GOLIATH BALL JOINT SERVICE TOOL AND MASTER ADAPTER SET

Make	Model	Year	Application	Removal	Installation
Infiniti	G20t	(99-02)	Fr. Lower NA RCA	NA	NA
	G35	(03-08)	Fr. Lower NA RCA	NA	NA
	G37	(08-13)	Fr. Lower NA RCA	NA	NA
	I30I	1997	Fr. Lower NA RCA	NA	NA
	I30t	(97-01)	Fr. Lower NA RCA	NA	NA
	J30	(93-97)	Fr. Lower NA RCA	NA	NA
	J30t	1997	Fr. Lower NA RCA	NA	NA
	M35	(06-10)	Fr. Lower NA RCA	NA	NA
	M37	(11-13)	Fr. Lower NA RCA	NA	NA
	M45	(03-10)	Fr. Lower NA RCA	NA	NA
	Q40	2015	Fr. Lower NA RCA	NA	NA
	Q45	(96-06)	Fr. Lower NA RCA	NA	NA
	Q45t	(97-01)	Fr. Lower NA RCA	NA	NA
	QX4	(97-03)	Fr. Lower NA (Bolt in)	NA	NA
	QX56	(07-13) (04-13)	Fr. Upper NA	NA	NA
			Fr. Lower NA RCA	NA	NA
			Rear Lower NA RCA	NA	NA
	Rear Upper NA RCA	NA	NA		
Isuzu	Amigo	(98-00)	Fr. Upper & Lower NA (Bolt in)	NA	NA
	Ascender 2WD / 4WD	(03-08)	Fr. Upper applicable		12, 18, 06
			Fr. Lower applicable	15, 08	16, 10
	Axiom	(02-04)	Fr. Upper & Lower NA (Bolt in)	NA	NA
	Hombre 2WD	(96-00)	Fr. Upper NA (Bolt in)	NA	NA
	Hombre 4WD	(96-00)	Fr. Upper & Lower NA (Bolt in)	NA	NA
	I-290	(06-08)	Fr. Upper & Lower NA (Bolt in)	NA	NA
	I-370	(06-08)	Fr. Upper & Lower NA (Bolt in)	NA	NA
	Oasis	(96-99)	Fr. Upper NA RCA	NA	NA
			Fr. Lower applicable		21, 06
	Pickup 2WD/4WD	(88-95)	Fr. Upper & Lower NA (Bolt in)	NA	NA
	Rodeo	(91-04) (96-04)	Fr. Lower NA (Bolt in)	NA	NA
			Fr. Upper NA (Bolt in)	NA	NA
	Trooper	(95-02) (92-02)	Fr. Lower NA (Bolt in)	NA	NA
Fr. Upper NA (Bolt in)			NA	NA	
VehiCROSS	(99-01)	Fr. Upper & Lower NA (Bolt in)	NA	NA	
Jaguar	S-Type	(00-08)	Fr. Lower NA in spindle	NA	NA
			Fr. & Rear Upper NA RCA	NA	NA
	Vanden	(94-97)	Fr. Upper & Lower NA (Bolt in)	NA	NA
	Plas	(98-04)	Fr. Upper & Lower NA RCA	NA	NA
	XJ	(03-16) 2003	Fr. Lower NA RSK	NA	NA
			Fr. Upper NA	NA	NA
		(04-16)	Fr. Upper NA RCA	NA	NA
			Fr. Upper & Lower NA (Bolt in)	NA	NA
	XJ6	(92-97)	Fr. Upper & Lower NA (Bolt in)	NA	NA
	XJ8	(98-05)	Fr. Upper & Lower NA RCA	NA	NA
	XJR	(95-97) (98-06)	Fr. Upper & Lower NA (Bolt in)	NA	NA
			Fr. Upper & Lower NA RCA	NA	NA
	XJS	(92-96)	Fr. Upper & Lower NA (Bolt in)	NA	NA
	XK	(03-14) (98-03)	Fr. Upper & Lower NA RCA	NA	NA
			Fr. Lower NA RCA	NA	NA
		(05-14) (97-14)	Fr. Lower NA RCA	NA	NA
			Fr. Upper NA RCA	NA	NA
	XKR	(00-14)	Fr. Upper & Lower NA RCA	NA	NA
X-Type	(01-09)	Fr. Lower NA RCA	NA	NA	
Jeep	Cherokee	(90-01)	Fr. Upper applicable	20, 12	18, 11
			Fr. Lower applicable	12, 20 or 21	18, 11
	Cherokee RHD	(96-98)	Fr. Upper applicable	20, 12	18, 11
			Fr. Lower applicable	12, 20 or 21	18, 11
	Commander 2WD/4WD	(06-10)	Fr. Lower applicable		10, 13
	Compass 2WD/4WD	(07-16)	Fr. Lower applicable	12, 18	

Make	Model	Year	Application	Removal	Installation
Jeep	Grand	(96-04)	Fr. Upper applicable	20, 12	18, 11
	Cherokee	(93-04)	Fr. Lower applicable	12, 20 or 21	18, 11
		(05-10)	Fr. Lower applicable		10, 13
	Grand Cherokee 2WD/4WD	(93-94)	Fr. Lower applicable	12, 20 or 21	18, 11
	Grand Wagoneer	(08-12)	Fr. Lower applicable		10, 13
	Liberty 2WD/4WD	(02-12)	Fr. Lower NA RCA	NA	NA
			Fr. Upper NA RCA	NA	NA
	Patriot 2WD/4WD	(07-10)	Fr. Lower NA RCA	NA	NA
	Wrangler	(87-17)	Fr. Upper applicable	20, 12	18, 11
			Fr. Lower applicable	12, 20 or 21	18, 11
Kia	Amanti (GH)	(07-10) (04-10)	Fr. Lower NA (Bolt in)	NA	NA
			Fr. Upper NA (Bolt in)	NA	NA
	Optima (MG)	(06-10)	Fr. Upper NA (Bolt in)	NA	NA
	Optima (MS)	(01-06)	Fr. Upper & Lower NA (Bolt in)	NA	NA
	Rio (DC)	(01-05)	Fr. Lower NA RCA	NA	NA
	Rio (JB)	(06-11)	Fr. Lower NA (Bolt in)	NA	NA
	Rondo (UN)	(07-10)	Fr. Lower NA (Bolt in)	NA	NA
	Sedona	(02-05) (06-14)	Fr. Lower NA RCA	NA	NA
			Fr. Lower NA (Bolt in)	NA	NA
	Sephia	(94-97) (98-03)	Fr. Lower NA (Bolt in)	NA	NA
			Fr. Lower NA (Bolt in)	NA	NA
	Sorento	(02-09)	Fr. Lower NA (Bolt in)	NA	NA
			Fr. Upper NA RCA	NA	NA
	Spectra (SD)	(00-04)	Fr. Lower NA (Bolt in)	NA	NA
Sportage	(95-02) (05-09)	Fr. Lower NA (Bolt in)	NA	NA	
		Fr. Upper NA RCA	NA	NA	
		Fr. Lower NA (Bolt in)	NA	NA	
Land Rover	Defender 90	(94-95) 1997	NA application	NA	NA
			NA application	NA	NA
	Discovery	(94-99)	NA application	NA	NA
	Discovery II	(00-04)	NA application	NA	NA
	Freelander	(02-05)	NA application	NA	NA
	LR3	2005	NA application	NA	NA
Range Rover	(95-05)	NA application	NA	NA	
Lexus	ES 300	(92-01) (02-03) (04-06)	Fr. Lower NA (Bolt in)	NA	NA
			Fr. Lower NA (Bolt in)	NA	NA
			Fr. Lower NA (Bolt in)	NA	NA
	ES 350	(07-12)	Fr. Lower NA (Bolt in)	NA	NA
	GS 300	(93-11)	Fr. Lower NA (Bolt in)	NA	NA
	GS 350	(05-08)	Fr. Lower NA (Bolt in)	NA	NA
	GS 400	(98-00)	Fr. Lower NA (Bolt in)	NA	NA
	GS 430	(01-07)	Fr. Lower NA (Bolt in)	NA	NA
	GS 450h	(07-17)	Fr. Lower NA (Bolt in)	NA	NA
	GX 470	(03-09)	Fr. Upper NA RCA	NA	NA
			Fr. Lower NA RCA	NA	NA
	IS 250	(06-13)	Fr. Lower NA (Bolt in)	NA	NA
	IS 300	(01-05)	Fr. Lower NA (Bolt in)	NA	NA
	IS 350	(06-13)	Fr. Lower NA (Bolt in)	NA	NA
	IS-F	(08-14)	NA application	NA	NA
	LS 400	(96-00)	Fr. Lower NA (Bolt in)	NA	NA
	LS 430	(01-06) (04-06)	Fr. Lower NA (Bolt in)	NA	NA
			Fr. Upper NA RCA	NA	NA
LS 460	(07-17)	Fr. Lower NA RCA	NA	NA	
LX 450	(96-97)	Fr. Lower NA RCA	NA	NA	
LX 470	(98-07)	Fr. Lower NA RCA	NA	NA	
		Fr. Upper NA RCA	NA	NA	
RX 300	(99-03)	Fr. Lower NA (Bolt in)	NA	NA	
RX 330	(04-06)	Fr. Lower NA (Bolt in)	NA	NA	
RX 350	(07-17)	Fr. Lower NA (Bolt in)	NA	NA	
RX 400h	(06-08)	Fr. Lower NA (Bolt in)	NA	NA	



Model:

78197

Product Type:

GOLIATH BALL JOINT SERVICE TOOL AND MASTER ADAPTER SET

GOLIATH BALL JOINT SERVICE TOOL AND MASTER ADAPTER SET

Make	Model	Year	Application	Removal	Installation
Lexus	SC 300	(96-00)	Fr. Upper & Lower NA RCA	NA	NA
	SC 400	(96-00)	Fr. Upper NA RCA	NA	NA
	SC 430	(02-10)	Fr. Lower NA (Bolt in)	NA	NA
Lincoln	Aviator 2WD/4WD	(03-05)	NA application	NA	NA
	Blackwood	2002	Fr. Lower applicable	19 or 04, 08	10, 03, 08
			Fr. Upper NA RCA	NA	NA
	Continental	(88-94)	Fr. Lower NA RCA	NA	NA
	LS	(00-06)	Fr. Lower NA RCA	NA	NA
	Mark LT	(06-07)	Fr. Upper NA RCA	NA	NA
	Mark LT (Base)	2008	Fr. Upper & Lower NA RCA	NA	NA
	Mark LT (HD)	2008	Fr. Upper & Lower NA RCA	NA	NA
	Mark VIII	(93-98)	Fr. Upper NA RCA	NA	NA
	MKX	(07-15)	Fr. Lower NA RCA	NA	NA
	MKZ	(07-12)	Fr. Lower NA RCA	NA	NA
	Navigator 2WD / 4WD	(98-02)	Fr. Lower applicable	19 or 04, 08	10, 03, 08
			Fr. Upper NA RCA	NA	NA
			Fr. Lower applicable	19	10, 03, 08 or 13
	Town Car	(95-02)	Fr. Lower applicable		20, 10, 06
Fr. Upper NA (Bolt in)			NA	NA	
Fr. Lower applicable			19		
Zephyr	2006	Fr. Lower NA RCA	NA	NA	
Mazda	626	(83-97)	Fr. Lower applicable		16, 10
			Fr. Lower NA RCA	NA	NA
	B series Truck 2WD/4WD	(91-93)	Fr. Upper & Lower NA (Bolt in)	NA	NA
	B-2300 2WD	(94-97)	Fr. Upper applicable	08, 03	21, 10
			Fr. Lower applicable	08, 03	08, 02, 10
	B-2300 2WD w/ Coil Spring suspension	(01-04)	Fr. Lower applicable	19	10, 03, 08 or 13
			Fr. Upper NA RCA	NA	NA
	B-2300 2WD w/ Torsion bar suspension	2001	Fr. Lower applicable	19 or 04, 08	10, 03, 08
	B-2300 2WD/4WD	(05-09)	Fr. Lower applicable	19	10, 03, 08 or 13
			Fr. Upper NA RCA	NA	NA
	B-2300 2WD/4WD w/Torsion bar suspension	(01-04)	Fr. Lower applicable	19	10, 03, 08 or 13
			Fr. Upper NA RCA	NA	NA
	B-2300 4WD	(95-97)	Fr. Upper applicable	08, 03	08, 02, 10 or 07, 09
			Fr. Lower applicable	08, 03	08, 02, 10 or 07, 09
	B-2500 2WD w/ Coil Spring suspension	(98-01)	Fr. Lower applicable	19	10, 03, 08 or 13
			Fr. Upper NA RCA	NA	NA
	B-2500 2WD w/ Torsion bar suspension	(98-01)	Fr. Lower applicable	19 or 04, 08	10, 03, 08
			Fr. Upper NA RCA	NA	NA
	B-2500 2WD/4WD w/Torsion bar suspension	(98-01)	Fr. Upper NA RCA	NA	NA
	B-2500 4WD w/ Torsion bar suspension	(98-01)	Fr. Lower applicable	19	10, 03, 08 or 13
	B-2600 4WD	(91-93)	Fr. Upper & Lower NA (Bolt in)	NA	NA
	B-3000 2WD	(94-96)	Fr. Upper applicable	08, 03	21, 10
			Fr. Lower applicable	08, 03	08, 02, 10
	B-3000 2WD w/ Coil Spring Suspension	(98-04)	Fr. Lower applicable	19	10, 03, 08 or 13
			Fr. Upper NA RCA	NA	NA
	B-3000 2WD w/ Torsion Bar Suspension	(98-01)	Fr. Lower applicable	19 or 04, 08	10, 03, 08
			Fr. Upper NA RCA	NA	NA
	B-3000 2WD/4WD	(05-09)	Fr. Lower applicable	19	10, 03, 08 or 13
Fr. Upper NA RCA			NA	NA	
B-3000 2WD/4WD w/Torsion bar suspension	(02-04)	Fr. Lower applicable	19	10, 03, 08 or 13	
		Fr. Upper NA RCA	NA	NA	
B-3000 4WD	(94-96)	Fr. Upper applicable	08, 03	08, 02, 10 or 07, 09	
		Fr. Lower applicable	08, 03	08, 02, 10 or 07, 09	
B-3000 4WD w/ Torsion bar suspension	(98-01)	Fr. Lower applicable	19	10, 03, 08 or 13	
B-4000 2WD	(94-97)	Fr. Upper applicable	08, 03	21, 10	
		Fr. Lower applicable	08, 03	08, 02, 10	
B-4000 2WD w/ Coil Spring Suspension	(98-04)	Fr. Lower applicable	19	10, 03, 08 or 13	
		Fr. Upper NA RCA	NA	NA	
B-4000 2WD w/ Torsion bar suspension	(98-01)	Fr. Lower applicable	19 or 04, 08	10, 03, 08	

Make	Model	Year	Application	Removal	Installation
Mazda	B-4000 2WD / 4WD	(05-09)	Fr. Upper applicable	19	10, 03, 08 or 13
			Fr. Lower applicable	19	10, 03, 08 or 13
	B-4000 2WD/4WD w/Torsion bar suspension	(02-04)	Fr. Lower applicable	19	10, 03, 08 or 13
			Fr. Upper NA RCA	NA	NA
	B-4000 4WD	(94-97)	Fr. Upper applicable	08, 03	08, 02, 10 or 07, 09
			Fr. Lower applicable	08, 03	08, 02, 10 or 07, 09
	B-4000 4WD w/ Torsion bar suspension	(98-01)	Fr. Lower applicable	19	10, 03, 08 or 13
	CX-7	(07-12)	Fr. Lower NA RCA	NA	NA
	CX-9	(06-15)	Fr. Lower NA RCA	NA	NA
	Mazda3	(04-09)	Fr. Lower NA RCA	NA	NA
	Mazda5	(06-15)	Fr. Lower NA RCA	NA	NA
	Mazda6	(02-09)	Fr. Lower NA RCA	NA	NA
			Fr. Upper NA (Bolt in)	NA	NA
	Mazda Speed 3	(07-13)	Fr. Lower NA RCA	NA	NA
	Miata	(90-05)	Fr. Lower NA (Bolt in)	NA	NA
	MX-5 Miata	(06-15)	Fr. Lower NA RCA	NA	NA
	Millenia	(95-02)	Fr. Lower NA (Bolt in)	NA	NA
	MPV	(99-06)	Fr. Lower NA RCA	NA	NA
	MPV 2WD	(89-98)	Fr. Lower NA RCA	NA	NA
	MPV 4WD	(96-98)	Fr. Lower NA (Bolt in)	NA	NA
	MX-6	(88-97)	Fr. Lower applicable		16, 10
	Navajo 2WD	(92-94)	Fr. Upper applicable	08, 03	21, 10
			Fr. Lower applicable	08, 03	08, 02, 10
	Navajo 4WD w/Dana 35 Axle	(91-93)	Fr. Lower applicable (Uses Pinch Bolt)	08, 03	08, 02, 10 or 07, 09
			Fr. Lower applicable	08, 03	08, 02, 10 or 07, 09
			Fr. Upper Applicable (uses Pinch Bolt)	08, 03	08, 02, 10 or 07, 09
	Protégé	(93-98)	Fr. Lower NA (Bolt in)	NA	NA
			Fr. Lower NA RCA	NA	NA
Protégé5	(02-03)	Fr. Lower NA RCA	NA	NA	
RX7	(86-95)	NA application	NA	NA	
RX8	(03-12)	Fr. Lower NA RCA	NA	NA	
Mercedes-Benz	C220	(94-97)	Fr. Lower NA (Bolt in)	NA	NA
			Fr. Upper NA RCA	NA	NA
	C230	(97-00)	Fr. Lower NA (Bolt in)	NA	NA
			Fr. Upper NA RCA	NA	NA
		(02-07)	Fr. & Rear Lower NA RCA	NA	NA
	C240	(01-05)	Fr. & Rear Lower NA RCA	NA	NA
			Fr. Upper NA RCA	NA	NA
	C280	(94-00)	Fr. Lower NA (Bolt in)	NA	NA
			Fr. Upper NA RCA	NA	NA
		(06-07)	Fr. & Rear Lower NA RCA	NA	NA
	C32 AMG	(02-04)	Fr. & Rear Lower NA RCA	NA	NA
	C320	(01-05)	Fr. & Rear Lower NA RCA	NA	NA
Fr. Upper NA RCA			NA	NA	
C350	(06-15)	Fr. & Rear Lower NA RCA	NA	NA	
		Fr. Lower NA (Bolt in)	NA	NA	
C36 AMG	(95-97)	Fr. Lower NA (Bolt in)	NA	NA	
		Fr. Upper NA RCA	NA	NA	
C43 AMG	(97-00)	Fr. Lower NA (Bolt in)	NA	NA	
		Fr. Upper NA RCA	NA	NA	
C55 AMG	(05-06)	Fr. & Rear Lower NA RCA	NA	NA	
CL500	(98-99)	Fr. Lower NA (Bolt in)	NA	NA	
		Fr. Upper NA RCA	NA	NA	
		NA application	NA	NA	
CL55 AMG	(01-06)	Fr. Upper & Lower NA RCA	NA	NA	
		Fr. Lower NA (Bolt in)	NA	NA	
CL600	(98-99)	Fr. Lower NA (Bolt in)	NA	NA	
		Fr. Upper NA RCA	NA	NA	
		Fr. Upper & Lower NA RCA	NA	NA	
CL65 AMG	(05-14)	Fr. Upper & Lower NA RCA	NA	NA	
		Fr. Lower NA (Bolt in)	NA	NA	
CLK320	(98-03)	Fr. Lower NA (Bolt in)	NA	NA	
		Fr. Upper NA RCA	NA	NA	



Model:

78197

Product Type:

GOLIATH BALL JOINT SERVICE TOOL AND MASTER ADAPTER SET

GOLIATH BALL JOINT SERVICE TOOL AND MASTER ADAPTER SET

Make	Model	Year	Application	Removal	Installation
Lexus	SC 300	(96-00)	Fr. Upper & Lower NA RCA	NA	NA
	SC 400	(96-00)	Fr. Upper NA RCA	NA	NA
	SC 430	(02-10)	Fr. Lower NA (Bolt in)	NA	NA
Lincoln	Aviator 2WD/4WD	(03-05)	NA application	NA	NA
	Blackwood	2002	Fr. Lower applicable	19 or 04, 08	10, 03, 08
			Fr. Upper NA RCA	NA	NA
	Continental	(88-94)	Fr. Lower NA RCA	NA	NA
	LS	(00-06)	Fr. Lower NA RCA	NA	NA
	Mark LT	(06-07)	Fr. Upper NA RCA	NA	NA
	Mark LT (Base)	2008	Fr. Upper & Lower NA RCA	NA	NA
	Mark LT (HD)	2008	Fr. Upper & Lower NA RCA	NA	NA
	Mark VIII	(93-98)	Fr. Upper NA RCA	NA	NA
	MKX	(07-15)	Fr. Lower NA RCA	NA	NA
	MKZ	(07-12)	Fr. Lower NA RCA	NA	NA
	Navigator 2WD / 4WD	(98-02)	Fr. Lower applicable	19 or 04, 08	10, 03, 08
		(98-06)	Fr. Upper NA RCA	NA	NA
		(03-14)	Fr. Lower applicable	19	10, 03, 08 or 13
	Town Car	(07-14)	Rear Lower applicable	19	10, 03, 08 or 13
(95-02)		Fr. Lower applicable		20, 10, 06	
(03-11)		Fr. Lower applicable	19		
Zephyr	2006	Fr. Lower NA RCA	NA	NA	
Mazda	626	(83-97)	Fr. Lower applicable		16, 10
		(98-02)	Fr. Lower NA RCA	NA	NA
	B series Truck 2WD/4WD	(91-93)	Fr. Upper & Lower NA (Bolt in)	NA	NA
	B-2300 2WD	(94-97)	Fr. Upper applicable	08, 03	21, 10
			Fr. Lower applicable	08, 03	08, 02, 10
	B-2300 2WD w/ Coil Spring suspension	(01-04)	Fr. Lower applicable	19	10, 03, 08 or 13
			Fr. Upper NA RCA	NA	NA
	B-2300 2WD w/ Torsion bar suspension	2001	Fr. Lower applicable	19 or 04, 08	10, 03, 08
		(05-09)	Fr. Lower applicable	19	10, 03, 08 or 13
	B-2300 2WD/4WD w/ Torsion bar suspension	(01-04)	Fr. Lower applicable	19	10, 03, 08 or 13
			Fr. Upper NA RCA	NA	NA
	B-2300 4WD	(95-97)	Fr. Upper applicable	08, 03	08, 02, 10 or 07, 09
			Fr. Lower applicable	08, 03	08, 02, 10 or 07, 09
	B-2500 2WD w/ Coil Spring suspension	(98-01)	Fr. Lower applicable	19	10, 03, 08 or 13
			Fr. Upper NA RCA	NA	NA
	B-2500 2WD w/ Torsion bar suspension	(98-01)	Fr. Lower applicable	19 or 04, 08	10, 03, 08
			Fr. Upper NA RCA	NA	NA
	B-2500 2WD/4WD w/ Torsion bar suspension	(98-01)	Fr. Upper NA RCA	NA	NA
	B-2500 4WD w/ Torsion bar suspension	(98-01)	Fr. Lower applicable	19	10, 03, 08 or 13
	B-2600 4WD	(91-93)	Fr. Upper & Lower NA (Bolt in)	NA	NA
	B-3000 2WD	(94-96)	Fr. Upper applicable	08, 03	21, 10
			Fr. Lower applicable	08, 03	08, 02, 10
	B-3000 2WD w/ Coil Spring Suspension	(98-04)	Fr. Lower applicable	19	10, 03, 08 or 13
			Fr. Upper NA RCA	NA	NA
	B-3000 2WD w/ Torsion Bar Suspension	(98-01)	Fr. Lower applicable	19 or 04, 08	10, 03, 08
			Fr. Upper NA RCA	NA	NA
	B-3000 2WD/4WD	(05-09)	Fr. Lower applicable	19	10, 03, 08 or 13
			Fr. Upper NA RCA	NA	NA
	B-3000 2WD/4WD w/ Torsion bar suspension	(02-04)	Fr. Lower applicable	19	10, 03, 08 or 13
		(98-04)	Fr. Upper NA RCA	NA	NA
	B-3000 4WD	(94-96)	Fr. Upper applicable	08, 03	08, 02, 10 or 07, 09
			Fr. Lower applicable	08, 03	08, 02, 10 or 07, 09
B-3000 4WD w/ Torsion bar suspension	(98-01)	Fr. Lower applicable	19	10, 03, 08 or 13	
B-4000 2WD	(94-97)	Fr. Upper applicable	08, 03	21, 10	
		Fr. Lower applicable	08, 03	08, 02, 10	
B-4000 2WD w/ Coil Spring Suspension	(98-04)	Fr. Lower applicable	19	10, 03, 08 or 13	
		Fr. Upper NA RCA	NA	NA	
B-4000 2WD w/ Torsion bar suspension	(98-01)	Fr. Lower applicable	19 or 04, 08	10, 03, 08	

Make	Model	Year	Application	Removal	Installation
Mazda	B-4000 2WD / 4WD	(05-09)	Fr. Upper applicable	19	10, 03, 08 or 13
			Fr. Lower applicable	19	10, 03, 08 or 13
	B-4000 2WD/4WD w/ Torsion bar suspension	(02-04)	Fr. Lower applicable	19	10, 03, 08 or 13
		(98-04)	Fr. Upper NA RCA	NA	NA
	B-4000 4WD	(94-97)	Fr. Upper applicable	08, 03	08, 02, 10 or 07, 09
			Fr. Lower applicable	08, 03	08, 02, 10 or 07, 09
	B-4000 4WD w/ Torsion bar suspension	(98-01)	Fr. Lower applicable	19	10, 03, 08 or 13
	CX-7	(07-12)	Fr. Lower NA RCA	NA	NA
	CX-9	(06-15)	Fr. Lower NA RCA	NA	NA
	Mazda3	(04-09)	Fr. Lower NA RCA	NA	NA
	Mazda5	(06-15)	Fr. Lower NA RCA	NA	NA
	Mazda6	(02-09)	Fr. Lower NA RCA	NA	NA
			Fr. Upper NA (Bolt in)	NA	NA
	Mazda Speed 3	(07-13)	Fr. Lower NA RCA	NA	NA
	Miata	(90-05)	Fr. Lower NA (Bolt in)	NA	NA
	MX-5 Miata	(06-15)	Fr. Lower NA RCA	NA	NA
	Millenia	(95-02)	Fr. Lower NA (Bolt in)	NA	NA
	MPV	(99-06)	Fr. Lower NA RCA	NA	NA
	MPV 2WD	(89-98)	Fr. Lower NA RCA	NA	NA
	MPV 4WD	(96-98)	Fr. Lower NA (Bolt in)	NA	NA
	MX-6	(88-97)	Fr. Lower applicable		16, 10
Navajo 2WD	(92-94)	Fr. Upper applicable	08, 03	21, 10	
		Fr. Lower applicable	08, 03	08, 02, 10	
Navajo 4WD w/Dana 35 Axle	(91-93)	Fr. Lower applicable (Uses Pinch Bolt)	08, 03	08, 02, 10 or 07, 09	
	(93-94)	Fr. Lower applicable	08, 03	08, 02, 10 or 07, 09	
	(91-94)	Fr. Upper Applicable (uses Pinch Bolt)	08, 03	08, 02, 10 or 07, 09	
Protégé	(93-98)	Fr. Lower NA (Bolt in)	NA	NA	
	(99-03)	Fr. Lower NA RCA	NA	NA	
Protégé5	(02-03)	Fr. Lower NA RCA	NA	NA	
RX7	(86-95)	NA application	NA	NA	
RX8	(03-12)	Fr. Lower NA RCA	NA	NA	
Mercedes-Benz	C220	(94-97)	Fr. Lower NA (Bolt in)	NA	NA
			Fr. Upper NA RCA	NA	NA
	C230	(97-00)	Fr. Lower NA (Bolt in)	NA	NA
			Fr. Upper NA RCA	NA	NA
		(02-07)	Fr. & Rear Lower NA RCA	NA	NA
	C240	(01-05)	Fr. & Rear Lower NA RCA	NA	NA
			Fr. Upper NA RCA	NA	NA
	C280	(94-00)	Fr. Lower NA (Bolt in)	NA	NA
			Fr. Upper NA RCA	NA	NA
		(06-07)	Fr. & Rear Lower NA RCA	NA	NA
C32 AMG	(02-04)	Fr. & Rear Lower NA RCA	NA	NA	
C320	(01-05)	Fr. & Rear Lower NA RCA	NA	NA	
		Fr. Upper NA RCA	NA	NA	
C350	(06-15)	Fr. & Rear Lower NA RCA	NA	NA	
		Fr. Lower NA (Bolt in)	NA	NA	
C36 AMG	(95-97)	Fr. Lower NA (Bolt in)	NA	NA	
		Fr. Upper NA RCA	NA	NA	
C43 AMG	(97-00)	Fr. Lower NA (Bolt in)	NA	NA	
		Fr. Upper NA RCA	NA	NA	
C55 AMG	(05-06)	Fr. & Rear Lower NA RCA	NA	NA	
CL500	(98-99)	Fr. Lower NA (Bolt in)	NA	NA	
		Fr. Upper NA RCA	NA	NA	
	(00-06)	NA application	NA	NA	
CL55 AMG	(01-06)	Fr. Upper & Lower NA RCA	NA	NA	
CL600	(98-99)	Fr. Lower NA (Bolt in)	NA	NA	
		Fr. Upper NA RCA	NA	NA	
	(01-06)	Fr. Upper & Lower NA RCA	NA	NA	
CL65 AMG	(05-14)	Fr. Upper & Lower NA RCA	NA	NA	
CLK320	(98-03)	Fr. Lower NA (Bolt in)	NA	NA	
		Fr. Upper NA RCA	NA	NA	



Model:

78197

Product Type:

GOLIATH BALL JOINT SERVICE TOOL AND MASTER ADAPTER SET

GOLIATH BALL JOINT SERVICE TOOL AND MASTER ADAPTER SET

Make	Model	Year	Application	Removal	Installation	
Mercedes-Benz	CLK320	(03-05)	Fr. & Rear Lower NA RCA	NA	NA	
	CLK350	(06-09)	Fr. & Rear Lower NA RCA	NA	NA	
			Fr. Upper NA RCA	NA	NA	
	CLK430	(99-03)	Fr. Lower NA (Bolt in)	NA	NA	
			Fr. Upper NA RCA	NA	NA	
	CLK500	(03-06)	Fr. & Rear Lower NA RCA	NA	NA	
			Fr. Upper NA RCA	NA	NA	
	CLK55 AMG	(01-03)	Fr. Lower NA (Bolt in)	NA	NA	
			Fr. Upper NA RCA	NA	NA	
			(03-06) Fr. & Rear Lower NA RCA	NA	NA	
	CLK550	(07-09)	Fr. & Rear Lower NA RCA	NA	NA	
			Fr. Upper NA RCA	NA	NA	
	CLK63 AMG	(06-10)	Fr. Upper & Lower NA RCA	NA	NA	
	CLS550	(06-10)	Fr. Upper & Lower NA RCA	NA	NA	
	CLS63 AMG	(06-14)	Fr. Upper & Lower NA RCA	NA	NA	
	E300	(95-99)	Fr. Lower NA (Bolt in)	NA	NA	
			Fr. Upper NA RCA	NA	NA	
	E320	(96-01)	Fr. Lower NA (Bolt in)	NA	NA	
			Fr. Upper NA RCA	NA	NA	
		2002	Fr. Lower NA (Bolt in)	NA	NA	
			Fr. Upper NA RCA	NA	NA	
		2003	Fr. Lower NA (Bolt in)	NA	NA	
	Fr. Upper NA RCA		NA	NA		
	(03-06)	Fr. Upper & Lower NA RCA	NA	NA		
	E350	(06-16)	Fr. Upper & Lower NA RCA	NA	NA	
	E420	(94-97)	Fr. Lower NA (Bolt in)	NA	NA	
			Fr. Upper NA RCA	NA	NA	
	E430	(98-02)	Fr. Lower NA (Bolt in)	NA	NA	
			Fr. Upper NA RCA	NA	NA	
	E500	(03-06)	Fr. Upper & Lower NA RCA	NA	NA	
	E55 AMG	(99-03)	Fr. Lower NA (Bolt in)	NA	NA	
			Fr. Upper NA RCA	NA	NA	
			(03-06) Fr. Upper & Lower NA RCA	NA	NA	
	E550	(07-14)	Fr. Upper & Lower NA RCA	NA	NA	
	E63 AMG	(07-16)	Fr. Upper & Lower NA RCA	NA	NA	
	G500	(02-05)	NA application	NA	NA	
	G55 AMG	(03-11)	NA application	NA	NA	
	G55K	2005	NA application	NA	NA	
	GL320	(07-08)	Fr. Lower NA RCA	NA	NA	
	GL450	(07-16)	Fr. Lower NA RCA	NA	NA	
	GLC63 AMG	2018	NA application	NA	NA	
	GT C AMG	2018	NA application	NA	NA	
ML320	(97-01)	Fr. Upper & Lower NA RCA	NA	NA		
		(05-08) Fr. Lower NA RCA	NA	NA		
ML350	(03-15)	Fr. Upper & Lower NA RCA	NA	NA		
ML430	(99-01)	Fr. Upper & Lower NA RCA	NA	NA		
ML500	(02-08)	Fr. Upper & Lower NA RCA	NA	NA		
ML55 AMG	(00-03)	Fr. Upper & Lower NA RCA	NA	NA		
ML63 AMG	(07-11)	Fr. Lower NA RCA	NA	NA		
S320	(94-99)	Fr. Lower NA (Bolt in)	NA	NA		
		Fr. Upper NA RCA	NA	NA		
S350	2006	Fr. Lower NA RCA	NA	NA		
S420	(94-99)	Fr. Lower NA (Bolt in)	NA	NA		
		Fr. Upper NA RCA	NA	NA		
S430	(00-06)	Fr. Lower NA (Bolt in)	NA	NA		
		Fr. Upper NA RCA	NA	NA		
S500	(94-99)	Fr. Lower NA (Bolt in)	NA	NA		
		Fr. Upper NA RCA	NA	NA		
Mercedes-Benz	S500	(00-06)	Fr. Lower NA (Bolt in)	NA	NA	
			Fr. Upper NA RCA	NA	NA	
	S550	(07-14)	Fr. Upper & Lower NA RCA	NA	NA	
	S55 AMG	(00-06)	Fr. Upper & Lower NA RCA	NA	NA	
	S600	(94-99)	Fr. Lower NA (Bolt in)	NA	NA	
			Fr. Upper NA RCA	NA	NA	
			(01-06) Fr. Upper & Lower NA RCA	NA	NA	
	(07-13)	Fr. Upper & Lower NA RCA	NA	NA		
	S63 AMG	(07-10)	Fr. Upper & Lower NA RCA	NA	NA	
	S65 AMG	(06-14)	Fr. Upper & Lower NA RCA	NA	NA	
	SL320	(94-97)	NA application	NA	NA	
	SL500	(94-02)	NA application	NA	NA	
			(03-06) Fr. Upper & Lower NA RCA	NA	NA	
	SL55 AMG	(03-08)	Fr. Upper & Lower NA RCA	NA	NA	
	SL600	(94-02)	NA application	NA	NA	
			(04-09) Fr. Upper & Lower NA RCA	NA	NA	
	SL65 AMG	(04-12)	Fr. Upper & Lower NA RCA	NA	NA	
	SLK230	(96-04)	Fr. Lower NA (Bolt in)	NA	NA	
			Fr. Upper NA RCA	NA	NA	
	SLK280	(06-08)	Fr. & Rear Lower NA RCA	NA	NA	
			Fr. Upper NA RCA	NA	NA	
	SLK32 AMG	(01-04)	Fr. Lower NA (Bolt in)	NA	NA	
	SLK320	(00-04)	Fr. Upper NA RCA	NA	NA	
			Fr. Lower NA (Bolt in)	NA	NA	
	SLK350	(04-11)	Fr. Upper & Lower NA RCA	NA	NA	
			Rear Lower NA RCA	NA	NA	
	SLK55 AMG	(04-11)	Fr. & Rear Lower NA RCA	NA	NA	
	Mercury	Cougar	(89-97)	Fr. Upper NA RCA	NA	NA
			(96-97)	Fr. Lower NA RCA	NA	NA
			(99-02)	Fr. Lower NA (Bolt in)	NA	NA
	Grand Marquis	(95-02)	Fr. Lower applicable		06, 10, 06	
			Fr. Upper NA (Bolt in)	NA	NA	
	(03-11)	Fr. Lower applicable	19			
		Fr. Upper NA RCA	NA	NA		
	Lynx	(84-87)	Fr. Lower NA RCA	NA	NA	
	Marauder	(03-04)	Fr. Lower applicable	19		
			Fr. Upper NA RCA	NA	NA	
	Montego	(05-07)	Fr. Lower NA RCA	NA	NA	
	Monterey	(04-07)	Fr. Lower NA RCA	NA	NA	
	Mountaineer	(97-05)	Fr. Lower applicable	19 or 04, 08	10, 03, 08	
			(97-01)	Fr. Upper NA RCA	NA	NA
			(02-05)	Rear Lower NA applicable	NA	NA
(06-10)			Fr. Lower NA RCA	NA	NA	
Mystique	(95-00)	Fr. Lower NA (Bolt in)	NA	NA		
Sable	(86-95)	Fr. Lower NA RCA	NA	NA		
		(08-09)	Fr. Lower NA RCA	NA	NA	
Topaz	(84-94)	Fr. Lower NA RCA	NA	NA		
Tracer	(91-99)	Fr. Lower NA (Bolt in)	NA	NA		
Villager	(93-02)	Fr. Lower NA (Bolt in)	NA	NA		
Mini	Clubman	(08-14)	Fr. Lower NA (Bolt in)	NA	NA	
		(11-18)	NA application	NA	NA	
		(01-13)	Fr. Lower NA (Bolt in)	NA	NA	
Mitsubishi	3000GT	(91-99)	Fr. Lower NA RCA	NA	NA	
			(96-04)	Fr. Lower NA RCA	NA	NA
	Eclipse	(90-94)	Fr. Lower applicable	12, 18	16	
			(95-01)	Fr. Lower NA RCA	NA	NA
			(06-12)	Fr. Lower NA RCA	NA	NA
(95-99)	Fr. Upper NA (Bolt in)	NA	NA			



Model:

78197

Product Type:

GOLIATH BALL JOINT SERVICE TOOL AND MASTER ADAPTER SET

GOLIATH BALL JOINT SERVICE TOOL AND MASTER ADAPTER SET

Make	Model	Year	Application	Removal	Installation	
Mitsubishi	Eclipse Cross	2018	NA application	NA	NA	
	Endeavor	(04-11)	Fr. Lower NA RCA	NA	NA	
	Galant	(85-93)	Fr. Lower applicable	12, 18	16	
		(94-99)	Fr. Lower NA RCA	NA	NA	
		(94-98)	Fr. Upper NA (Bolt in)	NA	NA	
	Lancer	(02-12)	Fr. Lower applicable	12, 18	02, 08	
	Mighty Max	(83-96)	Fr. Lower NA (Bolt in)	NA	NA	
	Mirage	(96-02)	Fr. Lower NA RCA	NA	NA	
		(12-17)	NA application	NA	NA	
	Montero	(92-06)	Fr. Upper & Lower NA (Bolt in)	NA	NA	
	Montero Sport	(97-04)	Fr. Upper & Lower NA (Bolt in)	NA	NA	
	Outlander	(03-17)	Fr. Lower NA RCA	NA	NA	
Raider	(06-09)	Fr. Lower applicable		10, 13		
Nissan	200SX	(95-98)	Fr. Lower applicable	12, 21		
	350Z	(03-09)	Fr. Lower NA RSK	NA	NA	
			Fr. Upper NA RCA	NA	NA	
	370Z	(09-18)	NA application	NA	NA	
	Altima	(93-97)	Fr. Lower applicable	12, 18		
		(98-01)	Fr. Lower applicable	12, 18	02, 08	
		(02-18)	Fr. Lower NA RCA	NA	NA	
	Armada	(04-15)	Rear Upper & Lower NA RCA	NA	NA	
	D21 Pickup 2WD/4WD	(91-97)	Fr. Upper NA (Bolt in)	NA	NA	
		(91-97)	Fr. Lower NA (Bolt in)	NA	NA	
	Frontier	(98-04)	Fr. Upper applicable		10, 17, 09, 06	
	Maxima	(03-14)	Fr. Lower NA RCA	NA	NA	
	Murano	(03-14)	Fr. Lower NA RCA	NA	NA	
			Rear Upper NA RCA	NA	NA	
	Pathfinder	(91-04)	Fr. Lower NA (Bolt in)	NA	NA	
		(91-95)	Fr. Upper NA (Bolt in)	NA	NA	
	Quest	(93-02)	Fr. Lower NA (Bolt in)	NA	NA	
		(04-09)	Fr. Lower NA RCA	NA	NA	
			Rear Upper NA RCA	NA	NA	
	Rogue	(08-13)	Fr. Lower NA RCA	NA	NA	
	Sentra	(91-99)	Fr. Lower applicable	12, 21		
		(07-12)	Fr. Lower NA RCA	NA	NA	
Versa	(07-12)	Fr. Lower applicable	12, 18			
Xterra	(00-04)	Fr. Upper applicable		10, 17, 09, 06		
Oldsmobile	88	(85-99)	Fr. Lower NA (Bolt in)	NA	NA	
	98	(85-96)	Fr. Lower NA (Bolt in)	NA	NA	
	Archieva	(92-98)	Fr. Lower NA (Bolt in)	NA	NA	
	Alero	(99-04)	Fr. Lower NA (Bolt in)	NA	NA	
	Aurora	(95-03)	Fr. Lower NA (Bolt in)	NA	NA	
	Bravada	(91-01)	Fr. Upper & Lower NA (Bolt in)	NA	NA	
	Bravada 2WD / 4WD	(02-04)	Fr. Upper applicable		12, 18, 06	
			Fr. Lower applicable	15, 08	16, 10	
	Cutlass	(97-99)	Fr. Lower NA (Bolt in)	NA	NA	
	Cutlass Ciera	(82-96)	Fr. Lower NA (Bolt in)	NA	NA	
	Cutlass Supreme	(88-97)	Fr. Lower NA (Bolt in)	NA	NA	
	Intrigue	(98-02)	Fr. Lower NA (Bolt in)	NA	NA	
	LSS	(96-99)	Fr. Lower NA (Bolt in)	NA	NA	
	Regency	(97-98)	Fr. Lower NA (Bolt in)	NA	NA	
	Silhouette	(99-01)	Fr. Lower NA (Bolt in)	NA	NA	
		(02-04)	Rear Upper & Lower NA RCA	NA	NA	
	Silhouette 2WD/4WD	(02-04)	Fr. Lower NA (Bolt in)	NA	NA	
	Silhouette APV	(90-98)	Fr. Lower NA (Bolt in)	NA	NA	
	Plymouth	Breeze	(96-00)	Fr. Lower NA RCA	NA	NA
		Grand Voyager	(88-00)	Fr. Lower applicable	12, 18 or 02, 09	21, 08
		Laser	(90-94)	Fr. Lower applicable	12, 18	16
		Prowler	(97-01)	Fr. Lower NA RCA	NA	NA

Make	Model	Year	Application	Removal	Installation
Plymouth	Voyager	(84-00)	Fr. Lower applicable	12, 18 or 02, 09	21, 08
		(01-03)	Fr. Lower applicable	12, 18	
Pontiac	Aztek	(01-05)	Fr. Lower NA (Bolt in)	NA	NA
			Rear Upper & Lower NA RCA	NA	NA
	Bonneville	(87-05)	Fr. Lower NA (Bolt in)	NA	NA
	Bonneville SSE	2003	Fr. Lower NA (Bolt in)	NA	NA
	Firebird	(93-02)	Fr. Upper NA (Bolt in)	NA	NA
	G3	(07-09)	Fr. Lower NA (Bolt in)	NA	NA
	G5 Soft Ride	(07-09)	Fr. Lower NA (Bolt in)	NA	NA
	G5 Sport Ride	(07-09)	Fr. Lower NA (Bolt in)	NA	NA
	G6	(05-10)	Fr. Lower NA RCA	NA	NA
	G8	(08-09)	Fr. Lower NA RCA	NA	NA
	Grand Am	(91-05)	Fr. Lower NA (Bolt in)	NA	NA
	Grand Prix	(88-08)	Fr. Lower NA (Bolt in)	NA	NA
	GTO	(04-06)	Fr. Lower NA RCA	NA	NA
	Montana	(99-06)	Fr. Lower NA (Bolt in)	NA	NA
		(02-06)	Rear Upper & Lower NA RCA	NA	NA
	Montana SV6	2005	Fr. Lower NA (Bolt in)	NA	NA
	Pursuit	(05-06)	Fr. Lower NA (Bolt in)	NA	NA
	Solstice	(06-10)	Fr. Lower NA RCA	NA	NA
	Sunfire	(95-05)	Fr. Lower NA (Bolt in)	NA	NA
	Torrent	(06-09)	Fr. Lower NA (Bolt in)	NA	NA
	Trans Sport	(90-98)	Fr. Lower NA (Bolt in)	NA	NA
	Vibe	(03-08)	Fr. Lower NA (Bolt in)	NA	NA
Porsche	911	(96-17)	NA application	NA	NA
	Boxster	(97-17)	NA application	NA	NA
	Cayenne	(03-17)	NA application	NA	NA
	Cayman	(06-17)	NA application	NA	NA
	Macan	(15-17)	NA application	NA	NA
Panamera	(10-16)	NA application	NA	NA	
Saab	900	(94-98)	Fr. Lower NA RCA	NA	NA
	9000	(86-98)	Fr. Lower NA (Bolt in)	NA	NA
	9-2	(05-06)	Fr. Lower NA (Bolt in)	NA	NA
	9-3	(99-12)	Fr. Lower NA RCA	NA	NA
	9-5	(99-11)	Fr. Lower NA (Bolt in)	NA	NA
9-7x	(05-08)	Fr. Upper applicable		12, 18, 06	
		Fr. Lower applicable	15, 08	16, 10	
Saturn	Astra	(08-09)	Fr. Lower NA (Bolt in)	NA	NA
	Aura	(07-10)	Fr. Lower NA RCA	NA	NA
	Ion	(03-07)	Fr. Lower NA (Bolt in)	NA	NA
	L100	(01-02)	Fr. Lower NA (Bolt in)	NA	NA
	L200	(01-03)	Fr. Lower NA (Bolt in)	NA	NA
	L300	(01-05)	Fr. Lower NA (Bolt in)	NA	NA
	LS	2000	Fr. Lower NA (Bolt in)	NA	NA
	LS1	2000	Fr. Lower NA (Bolt in)	NA	NA
	LS2	2000	Fr. Lower NA (Bolt in)	NA	NA
	LW1	2000	Fr. Lower NA (Bolt in)	NA	NA
	LW2	2000	Fr. Lower NA (Bolt in)	NA	NA
	LW200	(01-03)	Fr. Lower NA (Bolt in)	NA	NA
	LW300	(01-03)	Fr. Lower NA (Bolt in)	NA	NA
	Outlook	(07-10)	Fr. Lower NA RCA	NA	NA
	Relay	(05-07)	Fr. Lower NA (Bolt in)	NA	NA
			Rear Upper & Lower NA RCA	NA	NA
SC1	(96-02)	Fr. Lower NA RCA	NA	NA	
SC2	(96-02)	Fr. Lower NA RCA	NA	NA	
SKY	(07-10)	Fr. Lower NA RCA	NA	NA	
SL	(96-02)	Fr. Lower NA RCA	NA	NA	
SL1	(96-02)	Fr. Lower NA RCA	NA	NA	
SL2	(96-02)	Fr. Lower NA RCA	NA	NA	



Model:

78197

Product Type:

GOLIATH BALL JOINT SERVICE TOOL AND MASTER ADAPTER SET

GOLIATH BALL JOINT SERVICE TOOL AND MASTER ADAPTER SET

Make	Model	Year	Application	Removal	Installation	
Saturn	SW1	(96-01)	Fr. Lower NA RCA	NA	NA	
	SW2	(96-01)	Fr. Lower NA RCA	NA	NA	
	Vue	(02-10)	Fr. Lower NA (Bolt in)	NA	NA	
Scion	FR-S	(13-16)	NA application	NA	NA	
	Im	2016	NA application	NA	NA	
	tC	(05-10)	Fr. Lower NA (Bolt in)	NA	NA	
	xA	(04-06)	Fr. Lower NA RCA	NA	NA	
	Xb	(04-15)	Fr. Lower NA RCA	NA	NA	
	xD	(08-14)	Fr. Lower NA RCA	NA	NA	
	Subaru	B9 Tribeca	(06-14)	Fr. Lower NA (Bolt in)	NA	NA
Baja		(03-06)	Fr. Lower NA (Bolt in)	NA	NA	
BRZ		(13-17)	NA application	NA	NA	
Crosstrek		(13-15)	NA application	NA	NA	
Esteem		(96-02)	Fr. Lower NA RCA	NA	NA	
Forester		(97-08)	Fr. Lower NA (Bolt in)	NA	NA	
Impreza		(93-11)	Fr. Lower NA (Bolt in)	NA	NA	
Legacy		(90-09)	Fr. Lower NA (Bolt in)	NA	NA	
Outback		(00-09)	Fr. Lower NA (Bolt in)	NA	NA	
SVX		(92-97)	Fr. Lower NA (Bolt in)	NA	NA	
Suzuki		Aerio	(02-07)	Fr. Lower NA RCA	NA	NA
	Forenza	(04-08)	Fr. Lower NA (Bolt in)	NA	NA	
	Grand Vitara	(99-13)	Fr. Lower NA RCA	NA	NA	
	Reno	(05-08)	Fr. Lower NA (Bolt in)	NA	NA	
	Sidekick 2WD/4WD	(89-98)	Fr. Lower NA (Bolt in)	NA	NA	
	Sidekick Sport	(96-98)	Fr. Lower NA RCA	NA	NA	
	Swift	(96-01)	Fr. Lower NA RCA	NA	NA	
	SX4	(07-14)	Fr. Lower NA RCA	NA	NA	
	Verona	(04-06)	Fr. Lower NA RCA	NA	NA	
	Vitara	(99-06)	Fr. Lower NA RCA	NA	NA	
	X-90	(96-98)	Fr. Lower NA (Bolt in)	NA	NA	
	XL-7	(02-08)	Fr. Lower NA RCA	NA	NA	
	Toyota	4Runner	(96-02)	Fr. Upper applicable		21, 12, 06
				Fr. Lower NA (Bolt in)	NA	NA
			(03-09)	Fr. Upper NA RCA	NA	NA
			Fr. Lower NA RCA	NA	NA	
Avalon		(95-10)	Fr. Lower NA (Bolt in)	NA	NA	
Camry		(92-11)	Fr. Lower NA (Bolt in)	NA	NA	
Celica		(94-05)	Fr. Lower NA (Bolt in)	NA	NA	
Corolla		(96-08)	Fr. Lower NA (Bolt in)	NA	NA	
Echo		(00-05)	Fr. Lower applicable	12, 21		
FJ Cruiser		(07-14)	Fr. Upper & Lower NA RCA	NA	NA	
Highlander		(01-08)	Fr. Lower NA (Bolt in)	NA	NA	
Land Cruiser		(96-08)	Fr. Lower NA RCA	NA	NA	
Mirai		(15-17)	NA application	NA	NA	
Matrix		(03-08)	Fr. Lower NA (Bolt in)	NA	NA	
MR2 Spyder		(00-05)	Fr. Lower NA RCA	NA	NA	
Paseo		(92-97)	Fr. Lower NA (Bolt in)	NA	NA	
Previa		(91-97)	Fr. Lower NA (Bolt in)	NA	NA	
Prius		(01-09)	Fr. Lower NA (Bolt in)	NA	NA	
Rav4		(96-09)	Fr. Lower NA (Bolt in)	NA	NA	
Sequoia		(01-08)	Fr. Upper applicable		21, 12, 06	
			Fr. Lower NA (Bolt in)	NA	NA	
Sienna		(98-10)	Fr. Lower NA (Bolt in)	NA	NA	
Solara		(99-08)	Fr. Lower NA (Bolt in)	NA	NA	
Supra		(96-98)	Fr. Lower NA RCA	NA	NA	
T-100		(93-98)	Fr. Upper NA (Bolt in)	NA	NA	
			Fr. Lower NA (Bolt in)	NA	NA	
Tacoma		(95-04)	Fr. Lower NA (Bolt in)	NA	NA	
Tacoma 2WD	(95-04)	Fr. Upper NA (Bolt in)	NA	NA		

Make	Model	Year	Application	Removal	Installation	
Toyota	Tacoma 4WD	(95-04)	Fr. Upper applicable		21, 12, 06	
	Tacoma PreRunner 2WD	(95-04)	Fr. Upper applicable		21, 12, 06	
		(95-04)	Fr. Lower NA (Bolt in)	NA	NA	
	Tacoma	(05-15)	Fr. Lower applicable	14, 08	10, 03, 08	
	Tercel	(91-98)	Fr. Lower NA (Bolt in)	NA	NA	
	Tundra	(00-06)	Fr. Upper applicable		21, 12, 06	
		(07-13)	Fr. Upper NA RCA	NA	NA	
		(00-13)	Fr. Lower NA (Bolt in)	NA	NA	
	Venza	(09-15)	NA application	NA	NA	
	Yaris	(05-13)	Fr. Lower NA RCA	NA	NA	
	Volkswagen	Atlas	2018	NA application	NA	NA
		Cabrio	(95-02)	Fr. Lower NA (Bolt in)	NA	NA
		CC	(08-17)	NA application	NA	NA
		EOS	(07-15)	Fr. Lower NA (Bolt in)	NA	NA
Eurovan		(93-03)	Fr. Upper NA application	NA	NA	
			Fr. Lower NA (Bolt in)	NA	NA	
GLI		(08-11)	Fr. Lower NA (Bolt in)	NA	NA	
Golf		(99-05)	Fr. Lower NA (Bolt in)	NA	NA	
Golf (exc. VR6)		(96-98)	Fr. Lower NA (Bolt in)	NA	NA	
Golf GEN IV		2006	Fr. Lower NA (Bolt in)	NA	NA	
Golf GEN V		2006	Fr. Lower NA (Bolt in)	NA	NA	
Golf VR6		(96-98)	Fr. Lower NA (Bolt in)	NA	NA	
GTI		(07-08)	Fr. Lower NA (Bolt in)	NA	NA	
GTI GEN IV		(06-07)	Fr. Lower NA (Bolt in)	NA	NA	
GTI GEN V		2006	Fr. Lower NA (Bolt in)	NA	NA	
Jetta		(99-11)	Fr. Lower NA (Bolt in)	NA	NA	
Jetta (exc. VR6)		(88-98)	Fr. Lower NA (Bolt in)	NA	NA	
Jetta (exc. VR6) Old Style		1999	Fr. Lower NA (Bolt in)	NA	NA	
Jetta VR6		(94-98)	Fr. Lower NA (Bolt in)	NA	NA	
Jetta VR6 Old Style		1999	Fr. Lower NA (Bolt in)	NA	NA	
New Beetle		(98-11)	Fr. Lower NA (Bolt in)	NA	NA	
Passat		(96-05)	Rear Lower NA RCA	NA	NA	
			Fr. Upper NA RCA	NA	NA	
			Fr. Lower NA RCA	NA	NA	
			Rear Upper NA RCA	NA	NA	
		(06-15)	Fr. Lower NA (Bolt in)	NA	NA	
Passat (exc. VR6)		(90-97)	Fr. Lower NA (Bolt in)	NA	NA	
Passat VR6	(93-97)	Fr. Lower NA (Bolt in)	NA	NA		
Phaeton	(04-06)	Fr. Upper NA RCA	NA	NA		
		Fr. Lower NA RCA	NA	NA		
R32	2008	Fr. Lower NA (Bolt in)	NA	NA		
Rabbit	(06-09)	Fr. Lower NA (Bolt in)	NA	NA		
Tiguan	(08-18)	NA application	NA	NA		
		Fr. Lower NA RCA	NA	NA		
Touareg	(03-07)	Fr. Upper NA RCA	NA	NA		
		Fr. Lower NA RCA	NA	NA		
Touareg 2	(08-10)	Fr. Upper NA RCA	NA	NA		
		Fr. Lower NA RCA	NA	NA		
Volvo	850	(96-97)	Fr. Lower NA RCA	NA	NA	
	960	(92-98)	Fr. Lower NA (Bolt in)	NA	NA	
	C30	(08-13)	Fr. Lower NA RCA	NA	NA	
	C70	(98-13)	Fr. Lower NA RCA	NA	NA	
			Fr. Lower NA RCA	NA	NA	
	S40	(00-12)	Fr. Lower NA RCA	NA	NA	
			Rear Upper NA RCA	NA	NA	
	S60	(01-09)	Fr. Lower NA (Bolt in)	NA	NA	
	S70	(98-00)	Fr. Lower NA RCA	NA	NA	
	S80	(99-16)	Fr. Lower NA (Bolt in)	NA	NA	
	S90	1998	Fr. Lower NA (Bolt in)	NA	NA	
	V40	(00-04)	Fr. Lower NA RCA	NA	NA	
	V50	(05-12)	Fr. Lower NA RCA	NA	NA	



Model:

78197

Product Type:

GOLIATH BALL JOINT SERVICE TOOL AND MASTER ADAPTER SET

GOLIATH BALL JOINT SERVICE TOOL AND MASTER ADAPTER SET

<i>Make</i>	<i>Model</i>	<i>Year</i>	<i>Application</i>	<i>Removal</i>	<i>Installation</i>
Volvo	V50	(05-12)	Rear Upper NA RCA	NA	NA
	V60	(15-18)	NA application	NA	NA
	V70	(98-00)	Fr. Lower NA RCA	NA	NA
		(01-11)	Fr. Lower NA (Bolt in)	NA	NA
	V90	1998	Fr. Lower NA (Bolt in)	NA	NA

<i>Make</i>	<i>Model</i>	<i>Year</i>	<i>Application</i>	<i>Removal</i>	<i>Installation</i>
Volvo	XC60	(10-18)	NA application	NA	NA
		(03-07)	Fr. Lower NA (Bolt in)	NA	NA
	XC90	(08-16)	Fr. Lower NA RCA	NA	NA
		(03-15)	Fr. Lower NA (Bolt in)	NA	NA

* RCA = Replace Control Arm

* RSK = Replace Steering Knuckle